

**MINISTRY OF EDUCATION AND SCIENCE OF UKRAINE**

**SIMON KUZNETS KHARKIV NATIONAL UNIVERSITY  
OF ECONOMICS**

# **MACROECONOMICS**

**Textbook**

**Kharkiv  
S. Kuznets KhNUE  
2020**

UDC 330.101.541(075)

M12

**Authors:** PhD in Economics, Associate Professor M. Bril – subsections 7.1, 11.2, 11.3; PhD in Economics, Associate Professor O. Klimenko – section 9; PhD in Economics, Associate Professor I. Lisna – subsections 2.1, 2.3; PhD in Economics, Associate Professor A. Lytvynenko – section 6; Doctor of Economics, Associate Professor M. Mashchenko – section 3, subsections 10.3, 10.4, introduction; PhD in Economics, lecturer A. Mordovets – section 5; PhD in Economics, Associate Professor I. Pyvavar – subsections 7.2, 11.1, 11.2; PhD in Economics, Associate Professor O. Ponomarenko – subsections 2.2, 2.3; PhD in Economics, Associate Professor N. Stepanenko – section 1; PhD in Economics, Associate Professor T. Cherkashyna – sections 4, 8, subsections 10.1, 10.2; PhD in Economics, Associate Professor N. Shyfrina – section 12.

Рецензенти: професор кафедри міжнародних економічних відносин імені Артура Голікова Харківського національного університету імені В. Н. Каразіна, д-р екон. наук *О. А. Довгаль*; професор кафедри економічної теорії Національної юридичної академії імені Ярослава Мудрого, д-р екон. наук *О. С. Марченко*.

**Рекомендовано до видання рішенням ученої ради Харківського національного економічного університету імені Семена Кузнеця.**

Протокол № 9 від 27.05.2019 р.

*Самостійне електронне текстове мережеве видання*

**Macroeconomics** [Electronic resource] : textbook / M. Bril, O. Klimenko, I. Lisna et al. – Kharkiv : S. Kuznets KhNUE, 2020. – 237 p. (English)

ISBN 978-966-676-789-2

The key theoretical statements of modern macroeconomics have been covered. The main markets, and the structure of the elements of macroeconomic policy have been analyzed. The statistical data that characterize the key macroeconomic indicators are presented both for post-socialist countries of Central and Eastern Europe (Poland, the Czech Republic, Slovakia, Slovenia, Hungary) and advanced economies such as China, USA and Canada. The textbook aims to form students' competences in the analysis of main macroeconomic indicators, assessment of actual macroeconomic issues, investigation of the role of main economic actors in the current economic cycle, making optimal economic decisions by main economic actors (households, enterprises, government, nonresidents) in the conditions of macroeconomic instability and global turbulence.

For students, postgraduate students, lecturers as well as managers who are interested in pressing economic problems.

**UDC 330.101.541(075)**

© Bril M., Klimenko O.,

Lisna I. et al., 2020

© Simon Kuznets Kharkiv National University of Economics, 2020

ISBN 978-966-676-789-2

# Contents

<b>Introduction.....</b>	<b>5</b>
<b>1. Macroeconomics as a science.....</b>	<b>7</b>
1.1. The role of macroeconomics in the system of economic sciences.....	7
1.2. The subject matter, object and subjects of macroeconomics.....	9
1.3. The main problems, key terms and indicators of macroeconomics, their relationship.....	13
1.4. The main methods of macroeconomics. The methodology of macroeconomics.....	15
<b>2. Macroeconomic indicators in the system of national accounts.....</b>	<b>23</b>
2.1. The system of national accounts.....	23
2.2. Gross domestic product (GDP) and methods for calculation of GDP.....	25
2.3. The main macroeconomic indicators of income. National wealth .	29
<b>3. Labor market.....</b>	<b>38</b>
3.1. Employment and unemployment.....	38
3.2. Labor market and the mechanism of its functioning.....	44
3.3. State regulation of employment.....	48
<b>4. Commodity market.....</b>	<b>55</b>
4.1. Aggregate demand.....	55
4.2. Aggregate supply.....	65
4.3. The equilibrium between aggregate demand and aggregate supply.....	72
<b>5. Money market.....</b>	<b>84</b>
5.1. The mechanism of the money market.....	84
5.2. The banking system and the money supply.....	89
<b>6. The inflation mechanism.....</b>	<b>104</b>
6.1. The essence and the main types of inflation.....	104
6.2. The causes and effects of inflation. Antiinflationary policy.....	111
<b>7. Household consumption.....</b>	<b>122</b>
7.1. Consumption.....	122
7.2. The Keynesian model of consumer behaviour.....	129
<b>8. Private investment.....</b>	<b>138</b>
8.1. Saving and investment.....	138

8.2. Capital investment .....	144
8.3. The estimation of the profitability of investment projects .....	154
<b>9. Total expenditures and GDP .....</b>	<b>163</b>
9.1. The "expenditures – output" model .....	163
9.2. The "withdrawal – injection" model.....	165
9.3. The multiplier and accelerator concept.....	168
9.4. The equilibrium GDP under different levels of employment.....	172
<b>10. Economic dynamics .....</b>	<b>180</b>
10.1. The sources of economic growth .....	180
10.2. The main models of economic growth.....	187
10.3. The problems of economic growth in Ukraine .....	192
10.4. Economic cycles .....	193
<b>11. The state in the system of macroeconomic regulation .....</b>	<b>201</b>
11.1. The role of the state in the economy and the basic functions of the state.....	201
11.2. The nature of fiscal policy of the state .....	202
11.3. The nature of monetary policy of the state.....	210
<b>12. Foreign trade policy.....</b>	<b>219</b>
12.1. The balance of payments .....	219
12.2. The exchange rate .....	223
12.3. State regulation of foreign trade policy .....	227
<b>References and bibliography.....</b>	<b>235</b>
Main.....	235
Information resources .....	236
Methodological support.....	236

# Introduction

The prospects for economic development of Ukraine are associated with global integration processes. The increasing strengthening of world economic relations and globalization processes lead to the fact that the economy of each state becomes a part of the global economy. For Ukraine and other countries, it is important to use the world experience in managing public economy. Therefore, the use of macroeconomic theory in practical activity is playing an increasingly significant role. Joining the world community will only provide positive achievements in Ukraine if it is preceded by an objective assessment of the state of the national economy, determining the reserves of its economic growth, and forecasting the consequences of the state economic policy.

Macroeconomics studies the structure, the state of the main macroeconomic markets of the national economy, the methods for qualitative and quantitative analysis of markets, the dynamics of macroeconomic indicators, the state of foreign economic activities and economic security of the country, determines the prospects for countries' economic development.

This textbook was created in accordance with the syllabus of the academic discipline "Macroeconomics", approved at Simon Kuznets Kharkiv National University of Economics. Studying this discipline forms a complex of knowledge, abilities and skills that are an integral part of successful practical work of future specialists.

The textbook aims to consider the most important economic concepts, to provide insight into the mechanism of functioning of the economy at the national level and to study the foundations of the economic and financial policies of the state, taking into account the Ukrainian socio-economic, cultural and historical specifics.

The theoretical material is presented in accordance with the thematic plan of the academic discipline, in an adequate volume and taking into account the knowledge acquired by students.

The work consistently examines:

the subject matter of the academic discipline, the history of the development of macroeconomics as a science, the behavior of macroeconomic entities;

the problems of employment and unemployment, the mechanism of functioning of the labor market and social policy;

the causes and effects of inflation, the problems of anti-inflationary policies of the state;

the tools and methods of the state influence on the economic system, the mechanisms of the fiscal and monetary systems;

the issue of foreign economic policy of the state.

Having mastered the academic discipline "Macroeconomics", students must receive the following competences:

the ability to understand the economic content and importance of the main macroeconomic indicators in macroeconomic processes;

to analyze the structure of the national economy according to various criteria;

to study the economic development trends using the tools of macroeconomic analysis;

to calculate the indicators of the financial market and its most important components: monetary, stock and foreign exchange markets;

to apply the modern research tools and methods for forecasting and planning of the national economy;

to identify trends in foreign economic activity and economic security of the country.

The student acquires the following communication competences in the process of studying the academic discipline:

the ability to form a communicative strategy;

autonomy and responsibility;

integrated action management;

the ability to study further with a high level of autonomy.

The presentation of material on the topics is accompanied by a number of tasks for self-assessment: questions, heuristic and graphic exercises, tests, examples of solutions. There is also a list of references and literature recommended by the authors for a more detailed study of the discipline.

# 1. Macroeconomics as a science

In the context of globalization processes taking place in the world, the unification of countries into various unions and societies, the economy of each state becomes a part of the world economy. This requires, especially from those countries that have recently embarked on the path of market relations, the use of world experience in managing the national economy. Therefore, the confident use of macroeconomic theory in practical activities is acquiring an increasingly significant role. The prospects for economic development of Ukraine are associated with the global integration processes. Joining the world community will only allow a country to gain positive achievements if it is preceded by an objective assessment of the state of the national economy, determination of the reserves of its economic growth, and forecasting the consequences of the state's economic policy.

1.1. The role of macroeconomics in the system of economic sciences.

1.2. The subject matter, object and subjects of macroeconomics.

1.3. The main problems, key terms and indicators of macroeconomics, their relationship.

1.4. The main methods of macroeconomics. The methodology of macroeconomics.

**Key terms:** macroeconomics, macroeconomic analysis, regional economy, economic processes, state, business entities, aggregate indicators, national income, general price level, total employment and investment, economic growth, the household sector, the business sector, the public sector, the foreign sector, economic system, socio-economic relations, methods of macroeconomics, the methodology of macroeconomics.

## 1.1. The role of macroeconomics in the system of economic sciences

The mechanism of managing economic entities is considered at three levels – within the company (the patterns of its behavior are studied by microeconomics), within the framework of the regional economy (studied by mesoeconomics) and within the national economy as a whole system (studied

by the macroeconomics). Macroeconomics (from the Greek *macroos* – large) is a field of science that explores the patterns of functioning and development trends of the national economy as a whole, as well as the tools and regulation methods.

In other words, this is a science of aggregated behavior of subjects in the economy. It is the aggregate economic trends that are the subject of macroeconomic research.

Macroeconomics looks at the economy as a whole. It focuses on broad issues such as growth of production, the number of unemployed people, the inflationary increase in prices, government deficits, and levels of exports and imports. Microeconomics and macroeconomics are not separate subjects, but rather complementary perspectives on the overall subject of the economy.

Macroeconomics is the study of economics involving the phenomena that affect an entire economy, including inflation, unemployment, price levels, economic growth, economic decline and the relationship between all of these.

Macroeconomics deals with the economy as a whole; it examines the behavior of economic aggregates such as aggregate income, consumption, investment, and the overall level of prices. Aggregate behavior refers to the behavior of all households and firms together.

The macroeconomic approach to the study of economic processes and phenomena has a number of features.

Firstly, it is aimed at studying the principles of the formation of aggregate indicators characterizing the level or trends of the development of the economy as a whole: national income, general price level, total employment and investment, economic growth. The main subjects of a market economy (producers and consumers) are also considered as aggregate totalities. This means that the motives of behavior and actions of economic agents are interpreted in such a way as if all interconnected producers were united in the producing a national product, and all consumers were represented on the market as a combined consumer, and demanded this product in exchange for income received from the sale factors of production.

Secondly, in contrast to the microeconomic analysis, in which the decisions of producers and consumers and their actions in individual markets are considered independent, the study of the economy as a whole implies the need to consider the interaction between economic entities through a system of interconnected markets.



Thirdly, the macroeconomic approach expands the number of economic entities that determine the state and development of the economy. The composition of these entities, in addition to producers and consumers, is included in the state. In open models of the functioning of the national economy, foreign countries are also included in the macroeconomic analysis.

To achieve these aims, models that explain the relationship between such factors as national income, output, consumption, unemployment, inflation, savings, investment and international trade are developed by scientists. All these models rely on aggregated economic indicators, for instance, GDP, unemployment, price indexes [1, p. 20–23].

A specific task of macroeconomics is the knowledge, systematization, generalization and explanation of processes that are determined by the mechanism of functioning of the national economy as a whole. Macroeconomic analysis consists of national bookkeeping, predictive modeling. The analysis allows you to determine the macroeconomic parameters of the past period in order to obtain information about the functioning of the economy, which makes it possible to adjust and develop new economic concepts. Predictive modeling determines the factors and the way they may affect macroeconomic indicators in the future.

## **1.2. The subject matter, object and subjects of macroeconomics**

The basis of macroeconomics is the fundamental contradiction of human society – between the material needs of people and the economic resources that they own, considered from the perspective of the national economy as a whole. Since people's needs are unlimited, and economic resources are relatively limited, society is not able to fully satisfy its needs. But it may require an increase in the level of satisfaction of needs with available resources.

This can be achieved by increasing the efficiency of the use of resources, i.e. improving the functioning of the national economy in the following ways:

- ensuring full employment of resources;
- achievement of the full volume of production;

- rational distribution of available resources;
- raising the technical level of production.

From this, the practical function of macroeconomics follows – providing society with effective forms and methods of influencing the economy to achieve the highest level of satisfaction of material needs. Also, the main functions of macroeconomics are: cognitive, which researches the analysis of economic processes at the macro level and builds the models of these processes; educational – macroeconomics is called upon to produce a new type of economic thinking, to form a modern worldview; prognostic – with the help of which the prospects for the development of the economy are evaluated.

The subject of macroeconomics is the mechanism of functioning of the entire national economy without taking into account the specifics of individual industries, as well as factors which determine changes in this mechanism in the short and long term, and the way the state influences the flow of economic processes at the national economic level.

Macroeconomics examines economies at the aggregate (international, national, regional) level.

So, macroeconomics looks at the economy as a whole, how the markets, as a whole, interact at the national level.

The object of macroeconomics is national economy with its aggregate indicators.

The economic system is always in constant development, therefore, new problems arise and they require substantiation. The economic system is an ordered system of relations between producers and consumers of tangible and intangible goods and services.

#### **Interesting to know**

The main elements of the economic system are:

- economic relations between business entities;
- socio-economic relations, which are based on the corresponding formal norms of ownership, economic resources and results of economic activity;
- organizational forms of economic activity: division of labor, specialization and cooperation of production;
- economic mechanism, i.e. the way of regulation of economic activity on the macro level.

The object of macroeconomic analysis is the national economy. The national economy is a holistic system of relationships between business entities regarding the production, distribution and consumption of the national product in order to increase the welfare of the nation. The most important spheres of a national economy are the tangible and intangible production and non-production spheres. Each of these spheres has its own structure-forming elements – branches.

The subjects of macroeconomics include:

1) the household sector, which forms the supply of labor and the demand for goods, consumes part of the income received, and retains the other part. Households seek to maximize utility, i.e. achieve maximum consumption with minimum costs;

2) the business sector – the totality of all enterprises in the country that make a demand for factors of production, create a supply of goods and invest. In its activities, the business sector, as a rule, seeks to maximize profits;

3) the public sector, which creates such specific benefits as security, science, infrastructure services. The public sector, as a rule, does not pursue the goal of maximizing profits, but creates conditions for optimal functioning of the national economy. At the same time, as a macroeconomic entity, the state produces and purchases goods, levies taxes, pays transfers, and forms a money supply;

4) the foreign sector, which represents a set of economic entities abroad and foreign state institutions. The overseas sector is studied mainly to determine the state of the national balance of payments and exchange rate.

As an independent science, macroeconomics was formed in the early 30s of the twentieth century, during the global economic crisis. But studies of general economic trends at the macro level appeared much earlier.

So, back in the 16th century, the French economist Jean Bodin substantiated the study of the price level as a result of changing the ratio of the amount of money and goods. In the seventeenth century, W. Petty and G. King estimated the national income of France and England. In the eighteenth century, the founder of the French school of physiocrats F. Quesnay developed a macroeconomic model of the economic circuit, called the "Economic Table".

The representative of the classical school A. Smith in his works answered the question of market self-regulation through a pricing mechanism. Classic David Hume analyzed the balance of payments. A macroeconomic approach to the analysis of the process of social reproduction was used by

K. Marx in his two-sector model of simple and expanded reproduction of the aggregate social product.

The global crisis of 1929 – 1933 broke the basic postulate of the classical theory – the ability of the economy for rapid self-regulation. There was a need for a new macroeconomic theory. Its founder was the British economist John M. Keynes, who in his "General Theory of Employment, Interest and Money" proved the possibility of the existence of a market economy in a steady state of high unemployment and underutilized production capacity [2, p. 28].

Keynes substantiated the need for state regulation of the economy as a whole. For a long time Keynesian economic theory had been dominant in the area of macroeconomics and public policy. Keynes' ideas were developed in the works of his followers – J. Hicks, A. Hansen, P. Samuelson and others.

During the 70s of the 20th century it turned out that government intervention in the economy does not always give a positive result. Against this background the "neoclassical" theory began to develop as a response to the shortcomings of Keynesian economic theory. The monetarist trend, led by M. Friedman, as well as the classical economists, opposed government intervention in market regulation.

The theory of supply economics arose in connection with the inability of Keynesian theory to propose effective measures against stagflation, a simultaneous decline in production and rising prices.

The theory of rational expectations became quite common in the mid-70s, when inflation and unemployment were simultaneously observed in the economies of some countries. Its supporters proceeded from the fact that the ability of economic entities for rational actions can be implemented in practice by a market mechanism without government intervention.

Another significant trend that arose at the turn of the 19th – 20th centuries and has received global significance is an institutional sociological trend. Its founder is T. Veblen and the most famous representatives are W. Mitchell, J. Galbraith, M. Weber, J. Schumpeter. Representatives of this trend considered the economy as a system in which relations between business agents are formed under the influence of economic, political and socio-psychological factors [3, p. 32].

The mentioned alternative theories of macroeconomic regulation do not reduce the importance of Keynesian theory, but supplement it by deepening our understanding of the ready-made mechanism for the functioning of the economy. World practice indicates that in the process of state regulation of

the economy, this effect is achieved only under the conditions of a rational combination of fiscal and monetary policy.

### **1.3. The main problems, key terms and indicators of macroeconomics, their relationship**

The object of macroeconomic research can be more fully illustrated through its goals.

The main and determining goal of macroeconomic development is economic growth. The more goods and services are produced in the economy the higher the standard of living of the population is. A growing economy is characterized by increasing annual national output, which can be used not only to effectively meet needs, but also to develop social or scientific and technical programs.

Economic efficiency is another goal of macroeconomics. Efficient production develops with minimal cost, efforts and losses. The growth of economic efficiency is manifested in a reduction in costs per unit of product or in an increase in the product by the previous value of expenses. The main and general indicator of growth of economic efficiency of production in the national economy is the growth of national income per capita.

Economic freedom is the goal and principle of macroeconomics. It is determined by three main questions: what, how and for whom to produce. It is the freedom of business and trade, freedom of movement of capital and economic information, technological methods of production, the movement of labor from one industry to another, the desire of each consumer to choose and buy tangible goods and services in accordance with their tastes and preferences.

Equal distribution of income is an important goal of macroeconomics. People are naturally endowed with unequal abilities, grow in different circumstances and social environments, and have different amounts of capital and resources. These initial conditions give rise to differences in income. Depending on the effectiveness of the business, the acquired profession, remuneration and other circumstances, incomes are even more differentiated.

Economic security as a goal of macroeconomics refers to the disabled part of the population. To support this category, social insurance and government assistance play a special role.

The next target of macroeconomic development is a stable price level, which means the absence of sharp jumps in their dynamics. General price level is a new category, different from prices at the microlevel.

This rate reflects the cost of a wide range of various goods and services (market consumer basket) at different times.

The goal of any national economy is always to ensure a high level of employment. Work is a necessity for everyone who is willing and able to work. Labor must be paid according to the product made.

Increasing free time for the harmonious development of personality is another goal of macroeconomics. Free time is one of the general indicators of the country's standard of living.

An urgent goal of the 21st century is to maintain a balance of interaction with the environment. Production should be based on resource-saving, nature-protective, waste-free systems. This is important not only for the national economy, but also for global cooperation.

Maintaining an equilibrium foreign trade balance is also one of the goals of macroeconomics. For equilibrium in macroeconomics a balance between export and import is needed. This balance provides a stable exchange rate of the national currency.

The goals of macroeconomics determine the state economic policy, which is based on a clear identification of the optimal development priorities and communication of the above goals.

State regulation of the economy is the purposeful activity of the state in the legal, economic and social prerequisites which are needed for the effective functioning of the market mechanism and minimization of its negative consequences.

The state carries out a number of functions for regulation of the economy:

1) formation of a policy of the country's socio-economic development that defines the main goals and means of economic development. State economic policy is implemented through economic forecasts, plans and programs, which in a market economy are advisory in nature;

2) provision of legal bases of functioning of economy. The government determines the legal status of the forms of ownership, regulates relations between individual market entities;

3) protection of competition. To this end, the government carries out anti-monopoly policy;

4) redistribution of income and resources. To reduce income inequality, the government redistributes them in the form of transfer payments, regulates individual income by establishing a minimum wage and applying a progressive form of income taxation;

5) stabilization of the economy. The government affects the economic cycle by implementing fiscal and monetary policies [3, p. 43].

The main instruments of state regulation are as follows:

firstly, fiscal policy that defines the manipulation of taxes and government's spending in order to influence the economy;

secondly, monetary policy which is implemented with the help of the money, credit and banking systems of the country;

thirdly, income policy which is the state's policy to contain inflation either by direct control of wages and prices or by voluntary planning to increase wages and prices;

fourthly, foreign economic and trade policies aiming to improve the efficiency of foreign trade;

fifthly, social policy implemented by the state in the form of activities with the provision of social conditions for the life of the population.

## **1.4. The main methods of macroeconomics.**

### **The methodology of macroeconomics**

The macroeconomic method is a specific tool for scientific research. Macroeconomics uses both general and specific research methods.

General methods are methods inherent in any economic science:

the dialectical method – the study of economic phenomena in connection with other phenomena in their development, as well as a consistent study on the lower-to-higher and simple-to-complex basis;

the marginal analysis method – the method of additional quantities;

the methods of induction (movement from particulars to generals) and deduction (analysis carried out by studying from generals to particulars);

the analysis method – division of an individual element into its constituent parts for phased study of each, and synthesis – a combination of the already studied parts.

In general, there are a huge number of general methods, but within the framework of this topic, the specific methods of macroeconomics seem more important.

Specific methods are methods inherent only to macroeconomics:

aggregation, combination of phenomena and processes into a single whole. Macroeconomic aggregation extends over economic entities (households, firms, the state, foreign countries) and markets (goods and services, money, labor, capital, foreign exchange markets);

macroeconomic modeling, a method of creating simplified models that provide a description of economic phenomena and processes to identify the relationship between them;

the turnover of income and expenses, a study of commodity-cash flows in the territory of a given country, including import and export;

the method of accounting for stocks and flows. Stock is the state of an indicator at a certain point in time, for example, unemployment, public debt, savings, national wealth, etc. Flow is the amount of change in stock over a specific time period;

the method of withdrawals and injections, a consideration of the flow-expenses income;

the equilibrium or balance method on which the national accounting system is built.

#### **Interesting to know**

Macroeconomic models are widely used in macroeconomics, which are formalized (logically, graphically, and algebraically) descriptions of various economic phenomena and processes in order to identify functional relationships between them. Any model is a simplified, abstract reflection of reality, because the whole variety of specific details cannot be taken into account at the same time when conducting research.

The use of macroeconomic models makes it possible to optimize the combination of macroeconomic instruments, to coordinate measures of the government and the National Bank to manage cyclical fluctuations of the economy.

The macroeconomic analysis is based on the model of circular flows, or the model of the circulation of GDP, revenues and expenditures (Fig. 1.1).



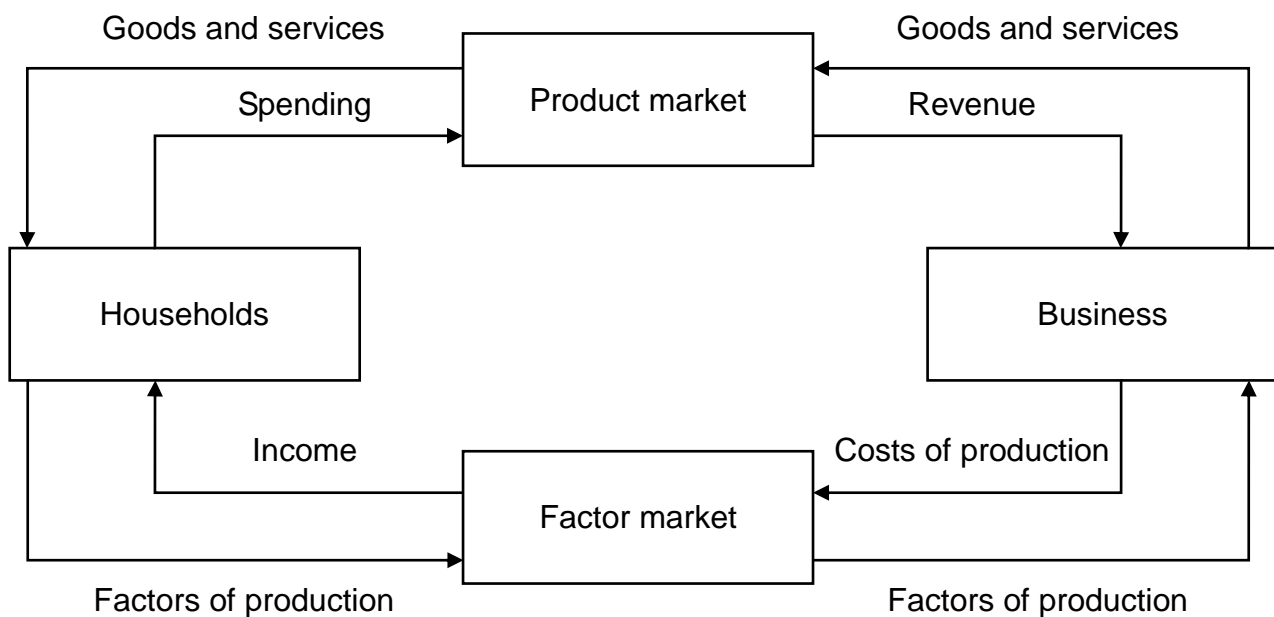

**Fig. 1.1. The model of circular flows**

In conclusion, the model of circular flows shows: real and cash flows are carried out without hindrance provided that the total expenditures of households, firms, the state and the outside world are equal to the total volume of production. Total expenses give an impetus to the growth of employment, output and income; from these revenues, the expenses of economic agents are financed again; these expenses are returned again in the form of income to the owners of factors of production, etc.

### **Inference**

Macroeconomics is the study of economics involving phenomena that affect an entire economy, including inflation, unemployment, price levels, economic growth, economic decline and the relationship between all of these. This is the science of the aggregate behavior of subjects in the economy. It is the aggregate economic trends that are the subject of macroeconomic research.

As macroeconomics studies economic growth, price stability, and full employment, a specific task of macroeconomics is the knowledge, systematization, generalization and explanation of processes that are determined by the mechanism of functioning of the national economy as a whole.

The subject of macroeconomics is the mechanism of functioning of the entire national economy without taking into account the specifics of individual industries, as well as factors which determine changes in this mechanism in the short and long term, and the way the state influences the flow of economic processes at the national economic level.

The national economy is the object of macroeconomic analysis. The most important spheres of a national economy are the tangible and intangible production and non-production spheres. Each of these spheres has its own structure-forming elements – branches.

The goals of macroeconomics determine the state economic policy, which is based on a clear identification of the optimal development priorities and communication of the above goals.

## **Glossary**

**Macroeconomics** is the study of economics involving phenomena that affect an entire economy, including inflation, unemployment, price levels, economic growth, economic decline and the relationship between all of these.

**The subject of macroeconomics** is the mechanism of functioning of the entire national economy without taking into account the specifics of individual industries, as well as factors which determine changes in this mechanism in the short and long term, and the way the state influences the flow of economic processes at the national economic level.

**The object of macroeconomics** is national economy with its aggregate indicators.

**Household sector** is a subject of macroeconomics that forms the supply of labor and the demand for goods, consumes part of the income received, and retains the other part.

**Business sector** is the totality of all enterprises in the country that have a demand for factors of production, create a supply of goods and invest.

**Public sector** creates such specific benefits as security, science, infrastructure services.

**Foreign sector** represents a set of economic entities abroad and foreign state institutions.

**Economic freedom** is the goal and principle of macroeconomics. It is determined by three main questions: what, how and for whom to produce.

**State regulation of the economy** is the purposeful activity of the state in the legal, economic and social prerequisites which are needed for the effective functioning of the market mechanism and minimization of its negative consequences.

**General methods** are methods inherent in any economic science.

**Specific methods of macroeconomics** are methods inherent only in macroeconomics.

### Questions for self-assessment

1. Give a definition of macroeconomics.
2. What scientists have made a significant contribution to the development of the theoretical foundations of the macroeconomic science?
3. What is the subject of macroeconomics?
4. What are the positive and normative functions of macroeconomics?
5. What are the main tools of macroeconomics?
6. What are the specifics of macroeconomic problems?
7. What are the main methods of macroeconomic analysis?
8. What are the main problems of modern macroeconomics?
9. What are the main macroeconomic methods?
10. List the main subjects of macroeconomics.

### Practical tasks

1. Match the macroeconomic methods with their main characteristics.

Methods	Characteristics
1. Induction	a) deducing the principles from the facts;
2. Deduction	b) a method of cognition that divides the whole into components and examines them separately;
3. Analysis	c) a method of cognition that unites the individual parts into one;
4. Synthesis	d) a method of cognition based on the conclusions from general's to particulars

2. Identify the relationship between macroeconomics and economic policy of the state. Explain your answer and confirm with examples from economic practice.

### Tests

1. If the economy is studied as an integrated system, then this analysis is called:

- a) microeconomic;
- b) macroeconomic;
- c) positive;
- d) normative;
- e) global;
- f) all answers are correct.

2. Macroeconomics examines economies at the:

- a) aggregate level;
- b) international level;
- c) national level;
- d) all answers are correct;
- e) all answers are incorrect.

3. One (some) of the main elements of the economic system is (are):

- a) economic relations between business entities;
- b) socio-economic relations, which are based on the corresponding formal norms of ownership, economic resources and results of economic activity;
- c) organizational forms of economic activity: division of labor, specialization and cooperation of production;
- d) the economic mechanism, i.e. the way of regulation of economic activity on the macrolevel;
- e) all answers are correct;
- f) all answers are incorrect.

4. The subjects of macroeconomics include:

- a) the household sector, which forms the supply of labor and the demand for goods, consumes part of the income received, and retains the other part;
- b) the business sector – the totality of all enterprises in the country that make a demand for factors of production, create a supply of goods and invest;

c) the public sector, which creates such specific benefits as security, science, infrastructure services;

d) the foreign sector, which represents a set of economic entities abroad and foreign state institutions;

e) all answers are correct;

f) all answers are incorrect.

5. The state carries out a number of functions for regulation of the economy:

a) provision of a policy of the country's socio-economic development that defines the main goals and means of economic development;

b) formation of legal bases of functioning of economy;

c) protection of competition (the government carries out anti-monopoly policy);

d) redistribution of income and resources;

e) all answers are correct;

f) all answers are incorrect.

6. Maintaining an equilibrium foreign trade balance is also one of the goals of:

a) macroeconomics;

b) microeconomics;

c) international economy;

d) national economy;

e) all answers are correct;

f) all answers are incorrect.

7. Fiscal policy:

a) defines the manipulation of taxes and government's spending in order to influence the economy;

b) is implemented with the help of the money, credit and banking systems of the country;

c) is the state's policy to contain inflation either by direct control of wages and prices or by voluntary planning to increase wages and prices;

d) aims to improve the efficiency of foreign trade;

e) is implemented by the state in the form of activities with the provision of social conditions for the life of the population.

8. Monetary policy:

a) defines the manipulation of taxes and government's spending in order to influence the economy;

b) is implemented with the help of the money, credit and banking systems of the country;

c) is the state's policy to contain inflation either by direct control of wages and prices or by voluntary planning to increase wages and prices;

d) aims to improve the efficiency of foreign trade;

e) is implemented by the state in the form of activities with the provision of social conditions for the life of the population.

8. Monetary income policy:

a) defines the manipulation of taxes and government's spending in order to influence the economy;

b) is implemented with the help of the money, credit and banking systems of the country;

c) is the state's policy to contain inflation either by direct control of wages and prices or by voluntary planning to increase wages and prices;

d) aims to improve the efficiency of foreign trade;

e) is implemented by the state in the form of activities with the provision of social conditions for the life of the population.

9. General methods of macroeconomics are:

a) dialectical method;

b) marginal analysis method;

c) methods of induction and deduction;

d) analysis method;

e) all answers are correct;

f) all answers are incorrect.

10. What is the economic goal if society is seeking to minimize costs and maximize returns on limited resources?

a) achievement of full employment;

b) maintaining economic growth;

c) economic security;

d) economic efficiency;

e) all answers are correct;

f) all answers are incorrect.

Answers: 1b; 2d; 3e; 4e; 5e; 6a; 7a; 8b; 9e; 10d.

## 2. Macroeconomic indicators in the system of national accounts

In every country there are thousands of interconnected entities. Together they make up the national economy or economy as a whole, it is researched by macroeconomics. In order to determine the state of the economy as a whole, it is necessary to summarize (aggregate) the state of the economies of each firm, each enterprise. As a result, data is obtained on the national volume of production, the general price level, employment and interest rate. Thus, aggregation allows obtaining statistical indicators characterizing the aggregate production of the society. Therefore, such indicators are called *macroeconomic*.

Analysis of the economic condition of the country is carried out using macroeconomic indicators and based on the system of national accounts (SNA).

2.1. The system of national accounts.

2.2. Gross domestic product (GDP) and methods for calculation of GDP.

2.3. The main macroeconomic indicators of income. National wealth.

**Key terms:** the system of national accounts, gross domestic product (GDP), gross national income (GNI), net national income, depreciation, personal disposable income, national wealth, transfers, methods for calculation of GDP and GNI, Paasche index, Laspeyres index, Fisher index, deflator, inflator, price index.

### 2.1. The system of national accounts

In the world practice, the most well-known methods for calculation of the main macroeconomic indicators are the System of Balance of the National Economy (SBNE) and the System of National Accounts (SNA).

The SBNE was created in the 1920s in the USSR (the first balance of the national economy describes the economy of the USSR in 1925 – 1926) and was used in all countries of the former socialist camp until its collapse.

The period of international standards of the SNA begins in 1947 with the publication of a UN report a significant part of which was written by R. Stone, a follower of J. Keynes. The important principles of national accounting were formulated in this report. In 1951, on behalf of the Organization of the European Economic Community, R. Stone prepared a message entitled "A Simplified SNA", which took into account the restrictions associated with obtaining the data necessary for national accounts. The following year, it was replaced by a more detailed Standard SNA. In 1953, the UN, under the leadership of R. Stone, prepared The SNA and Supporting Tables which is usually regarded as the first UN standard in national accounts. It was designed not only for developed countries but also for developing ones.

The second standard of the SNA was adopted by the UN Statistical Commission in 1968. An important innovation was the usage of the double-entry accounting principle of the SNA. In 1968, the UN began issuing a statistical yearbook, since most countries have implemented this standard in regular statistical practice. Based on the UN SNA of 1968, the European Economic Community (EEC) developed the European SNA standard at the beginning of 1970.

The UN Statistical Commission adopted a new and so far latest version of the SNA in 1993. According to this version, the SNA is defined as a set of indicators of a consistent and interconnected description of the most important processes and phenomena of the economy: production, income, consumption, capital accumulation, finance.

Since the SNA was created much later than the SBNE, it borrowed from the latter: the tables that reflect the intersectional relations of the economy; the distribution of final consumption into collective and individual; the concept of total consumption, etc.

At the same time, there are *differences between* the SNA and the SBNE. The main ones are, firstly, that the basis of the SBNE was the reproduction of the aggregate social product (gross social product), which evaluated the output of material production, but ignored the main share of the service sector; secondly, this scheme included a double count; thirdly, only one factor of production took part in creating the income of society – labour; fourthly, the scheme had an underdeveloped system of indicators, especially in the field of finance, etc.

*The main methodological principles of building the SNA* are: 1) the economic turnover of the economy is reflected in production, distribution and end use;



2) any activity that brings income to its subjects is considered productive, therefore, the country's income can be created both in the sphere of material production and in the service sector; 3) the cost of consumed production factors is equal to factor income, etc.

A feature of SNA-93 is that it is not built on *the concept of factor income* (state revenues are obtained as a result of the redistribution of primary income of the four main factors of production – labour, land, capital, entrepreneurial ability), but on *the modern concept of primary income*. The starting point of the latter concept is that government bodies are also an essential factor of production, therefore, *primary income* is the income that economic entities receive in the process of the initial distribution of the created value. *The form of government revenue* for this concept is taxes on production and imports.

The transition of most countries to the SNA-93 made it possible to conduct a comparative analysis of the effectiveness of the functioning of national economies, which is especially important in the context of the globalization of economic development.

## **2.2. Gross domestic product (GDP) and methods for calculation of GDP**

One of the main macroeconomic indicators evaluating the results of the economic activity of the national economy is GDP.

*GDP (gross domestic product)* is the value of the final product produced by residents of a given country for a certain period of time.

*Residents* are the institutional units whose economic interests are concentrated in the territory of a given country.

*The final product* is intended for final consumption, investment (accumulation) and export. *Intermediate products* are used for intermediate consumption.

GDP is measured in different ways, so there may be nominal and real GDP. *Nominal GDP* is calculated in prices of the current year, while real GDP is presented in comparable prices, that is, the prices of the base period.

The value of nominal GDP changes under the influence of the dynamics of the real volume of production and the dynamics of the price level.

Real GDP is calculated by adjusting the nominal GDP to the price index by the formula:

$$\text{Real GDP} = \frac{\text{Nominal GDP}}{\text{Price index}} \times 100 \% . \quad (2.1)$$

If the value of the price index is  $>1$ , then real GDP is less than nominal, therefore deflation is observed – the adjustment of nominal GDP in the direction of its reduction by lowering the price level of the current year to the price level of the base year, i.e. artificial deflation.

If the value of the price index is  $<1$ , then the nominal GDP is adjusted upward by inflation (artificial inflation).

The following aggregated indices are most often used to analyze nominal and real GDP values:

1) *the consumer price index (CPI)* which reflects the change in the consumer basket, characterizing the typical level and structure of the annual (monthly) consumption of households and is used to calculate the cost of living. The composition of the consumer basket is fixed at the base year level, which leads to an increase in the cost of living. This index is also called the Laspeyres index which is determined by the formula:

$$I_L = \frac{\sum_{i=1}^n P_i^1 \times Q_i^0}{\sum_{i=1}^n P_i^0 \times Q_i^0} , \quad (2.2)$$

where  $P_i^0$  and  $P_i^1$  is the price level of the  $i$ -th good in the base (0) and current (1) years respectively;

$Q_i^0$  is the amount of the  $i$ -th good in the base period;

2) *the GDP deflator or Paasche index* which reflects the change in the value of goods and services produced in the country's economy over a certain period of time. The Paasche index is determined by the formula:

$$I_P = \frac{\sum_{i=1}^n P_i^1 \times Q_i^1}{\sum_{i=1}^n P_i^0 \times Q_i^1} , \quad (2.3)$$

where  $Q_i^1$  is the amount of the  $i$ -th goods consumed in the current period;

Unlike the Laspeyres index, the Paasche index rather underestimates the rise in the price level in the economy.

If, instead of the  $i$ -th goods, we substitute the entire set of goods represented in the GDP, then we get the *GDP deflator*.

$$D = \frac{GDP_N}{GDP_R}, \quad (2.4)$$

where D is deflator;

$GDP_N$  is nominal GDP;

$GDP_R$  is real GDP;

3) *the Fisher index* which is used to partially eliminate the deficiencies of the Laspeyres and Paasche indices. It is determined by the formula:

$$I_F = \sqrt{I_P \times I_L}, \quad (2.5)$$

where  $I_F$  is Fisher index;

$I_P$  is Paasche index;

$I_L$  is Laspeyres index.

There are three main methods for measuring GDP:

- value added (production method);
- expenditure (end-use method);
- income-based (distribution method).

The production method implies calculation of GDP by summing the added values.

Value added is calculated by subtracting intermediate consumption from the gross output. Output is the total value of all goods and services produced by the economy for a certain period of time.

Since the general government sector is also involved in the creation of GDP, according to the SNA-93:

$$GDP = \text{gross value added} + \text{net taxes}, \quad (2.6)$$

$$\begin{aligned} \text{Net taxes} = & \text{taxes on products and imports} - \\ & - \text{subsidies for products and imports.} \end{aligned} \quad (2.7)$$

Taxes on products are set in proportion to the value or volume of manufactured and sold products (VAT, excise tax, sales tax, etc.).

Production taxes are set in proportion to production factors (land tax, fixed capital, wage funds, construction). Subsidies are treated as negative taxes and are subdivided into subsidies for products and subsidies for production similar to the corresponding taxes.

This method for measuring GDP takes into account the contribution of various firms and industries to the creation of GDP. For the economy as a whole, the sum of all added values must be equal to the value of the final goods and services.

The method for calculation of GDP based on expenditure (the end-use method) includes the following articles:

a) household expenses or consumption (C). They consist of consumer spending on consumer goods, durable goods and services but do not include the cost of buying accommodation;

b) public procurement of goods and services or government expenditures (G). These are expenses related to purchasing enterprise products and resources for the needs of the state, expressed in the sum of the costs to pay salaries to civil officers, the costs of construction of roads, hospitals, etc. Transfer payments are not included in government expenditures under this article – payments by government bodies that are not related to the movement of goods and services (for example, pensions, scholarships, benefits, etc.);

c) gross investment (I), which consists of investment in fixed assets, investment in housing, investment in stocks:

$$\text{Gross investment} = \text{net investment} + \text{depreciation.} \quad (2.8)$$

From the point of view of macroeconomics, the cost of acquiring securities does not apply to investments because it is not about creating new ones but about redistributing the existing assets, i.e. about their transfer from one owner to another.

In the SNA-93, the investment expenditures specify the net acquisition of values – the items that serve to preserve value (and, over time, their value grows). These are precious metals, stones, antiques, etc., which were previously included in consumer spending;

d) net exports ( $N_x$ ), which are equal to the difference between the export and import of the country. This parameter reflects the net consumption of goods and services by foreign countries.

Thus, the formula for determining GDP by the expenditure method has the form:

$$\text{GDP} = C + G + I + N_x. \quad (2.9)$$

The method for calculation of GDP based on income (the distribution method) includes the following articles:

a) salaries of employees;

b) gross profit and gross mixed income, which consists of profits of firms and corporations; income of unincorporated enterprises, individually or family-owned, and income of independent workers – artists, writers, lawyers and other self-employed workers; rent payment, i.e. income received by owners of land, real estate, etc.; interest on borrowed capital; depreciation;

c) indirect taxes on products and imports (value added tax, sales taxes, excise tax, etc.). These exclude subsidies for production and imports. In the practice of market economy, this article is considered as the primary income of government.

GDP calculated using all three methods should be equal to one value.

The difficulties in calculating GDP are mainly associated with the presence of an unobservable economy – a set of economic phenomena that are not recorded by direct observation carried out by statistical, fiscal, customs and other state systems to collect information. It can be conditionally divided into: 1) shadow production (tax evasion and unaccounted labour); 2) illegal production (prohibited production of goods and services; activities that do not comply with the mandatory requirement, for example, unlicensed, etc.); 3) production in the informal sector (household enterprises engaged in the production of goods and/or services in order to ensure employment and income of people participating in it); 4) household production for their own final use.

### **2.3. The main macroeconomic indicators of income.**

#### **National wealth**

The SNA-93 provides for several interrelated flow indicators that complement the GDP indicator. Their main characteristics are that they are only indicators of income. Therefore, when analyzing their structure, it is

impossible to apply calculation methods to production and usage. They do not characterize the cost of final production, but only the income that individuals and legal entities receive from various types of activity both in the country and abroad.

Macroeconomic indicators of income primarily include the indicator of *gross national income (GNI)* which until 1993 was called the gross national product (GNP). Let's recall that GNI is calculated by the formula:

$$\text{GNI} = \text{GDP} + \text{DN}, \quad (2.10)$$

where GDP is gross domestic product; DN is the difference between the income of residents of a given country received from abroad and income of non-residents transferred abroad from this country (*net income from abroad*).

GNI (*gross national income*) is the aggregate of primary income received by residents of a country from productive activities and from property.

Indices of domestic product and income can be calculated on both a gross and net basis.

$$\text{NDP (net domestic product)} = \text{GDP} - \text{depreciation}; \quad (2.11)$$

$$\text{NNI (net national income)} = \text{GNI} - \text{depreciation}. \quad (2.12)$$

The whole country's income (both earned and received from the rest of the world), which can be controlled by the national economy, can be determined using the macro indicator of *gross national disposable income (GNDI)*:

$$\text{GNDI} = \text{GNI} + \text{net current transfers received from the rest of the world}. \quad (2.13)$$

*Transfers* are economic operations through which some institutional units transfer goods, services, assets or property rights to other institutional units free of charge and irrevocably.

An important role in the analysis of the results of the reproductive process that has developed over a long period of time is cast for the indicator of national wealth, since it forms material prerequisites and determines the result of the process of social reproduction.

*National wealth (NW)* is the sum of assets that are the property of households, firms, and the state accumulated by society over the entire history of its existence.

*The structure of the NW* is as follows: 1) the explored and unexplored natural resources of the country; 2) the accumulated products of past labour; 3) financial assets; 4) intangible assets (patents, know-how, etc.); 5) intangible wealth associated with human resources (level of education and health of the nation, its economic security, etc.).

Such components of the NW as unexplored natural resources and human resources were not found to be valued in the SNA-93.

SNA-93 lacks such indicators as national income (NI), personal income (PI) and personal disposable income (PDI) which were in SNA-68 and are still widely used in macroeconomic analysis. Here are the most common formulas for calculation of these indicators:

$$NI = NNI - T_{nit}, \quad (2.14)$$

$$T_{nit} = T_i - S_b, \quad (2.15)$$

where  $T_{nit}$  is net indirect taxes;

$T_i$  is indirect taxes on business;

$S_b$  is business subsidies.

$$PI = NI - \text{charges on social insurance} - \text{taxes on profits of enterprises and corporations} - \text{retained earnings of enterprises and corporations} - \text{net interest on debt} + \text{government transfers and payments to households}, \quad (2.16)$$

$$PI = \text{state transfers to households} + \text{labour income} + \text{distributed profits (dividends)}, \quad (2.17)$$

$$PDI = PI - T_p, \quad (2.18)$$

where  $T_p$  is the individual profit taxes of citizens.

## Glossary

**GDP (gross domestic product)** is the value of the final product made by residents of a given country for a certain period of time.

**Residents** are the institutional units whose economic interests are concentrated in the territory of a given country.

**Final product** is product intended for final consumption, investment (accumulation) and export.

**Intermediate products** are products used for intermediate consumption.

**Consumer price index (CPI)** is the index that reflects the change in the consumer basket, characterizing the typical level and structure of the annual (monthly) consumption of households and is used to calculate the cost of living.

**GDP deflator or Paasche index** is the index that reflects the change in the value of goods and services produced in the country's economy over a certain period of time.

**National wealth (NW)** is the sum of assets that are the property of households, firms, and the state accumulated by society over the entire history of its existence

**GNI (gross national income)** is the aggregate of primary income received by residents of a country from productive activities and from property.

### **Problems with examples of solutions**

**Problem 1.** Calculate the country's GDP if its economy is characterized by the following data (billion euros): gross investment – 28, rent – 15, personal spending on consumption – 70, government spending – 21, export – 5, import – 7, transfers – 3 depreciation – 5.

*Solution.* According to the conditions of problem 1, the data is sufficient only for calculating the GDP by the end-use method using the formula:

$$\begin{aligned} \text{GDP} &= C + I + G + X \\ \text{GDP} &= 70 + 28 (5 - 7) = 114 \text{ (billion euros)}. \end{aligned}$$

Since government spending consists of government procurement of goods and services and transfers, we must reduce them by the amount of transfers in order to avoid double counting.



In this task, there is redundant data that is not used in calculating GDP – rent and depreciation.

**Problem 2.** Determine the growth rate of real GDP in the current year if it is known that the country's nominal GDP in the base year was 157 conventional units, and this year – 178 conventional units. The current year's GDP deflator is 103.2 %.

*Solution.* The growth rate of real GDP in the current year is found by the formula:

$$R_r = ((GDP_{1y} - GDP_{0y}) / GDP_{0y}) \times 100 \%,$$

where  $GDP_{1y}$  is the real GDP in the current year,

$GDP_{0y}$  is the real GDP in the base year.

The real GDP in the current year is found by the formula:

$$GDP_{1r} = GDP_{1n} / D_1 = 178 / 1.032 = 172.481 \text{ conventional units.}$$

In the base year, the real and nominal values are equal to each other (there is no inflation), because:

$$GDP_{0r} = GDP_{0n} = 157 \text{ conventional units.}$$

From here, we find the growth rate of real GDP in the current year:

$$R_r = (172.481 - 157) / 157 \times 100 \% = 9.861 \%.$$

**Problem 3.** Any country produces and consumes two goods. According to the table, determine the Laspeyres, Paasche and Fisher indices (2018 is the base period).

Goods	2018		2019	
	Unit price	Amount of goods	Unit price	Amount of goods
A	18	5	21	6
Б	41	13	36	11

*Solution.* The Laspeyres index is calculated for the prices in the base period:

$$I_L = \frac{\sum_{i=1}^n P_i^1 \times Q_i^0}{\sum_{i=1}^n P_i^0 \times Q_i^0},$$

$$I_L(18 \times 5 + 41 \times 13) = 573 / 623 = 0.92.$$

The Paasche index is calculated for the prices in the current period:

$$I_P = \frac{\sum_{i=1}^n P_i^1 \times Q_i^1}{\sum_{i=1}^n P_i^0 \times Q_i^1},$$

$$I_P(18 \times 6 + 41 \times 11) = 522 / 559 = 0.93.$$

Both indices show a decrease in the cost of living in 2012 compared to 2000.

The Fisher index averages the result:

$$I_F = \sqrt{I_L \times I_P} = \sqrt{0.92 \times 0.93} = 0.925.$$

1. Calculate the country's GDP as the sum of expenditures and the amount of income if the components of GDP (billion euros) for a certain year are: net investment – 18, rent – 6, public procurement of goods and services – 11, depreciation – 8, personal expenses for consumption – 27, profit of joint-stock enterprises – 20, indirect taxes on business – 3, net export – (– 5), interest – 2, salary – 12, income of individual owners – 3, transfers – 3.

2. Calculate GDP using the production method if the country's economy is characterized by the following data (billion euros): gross output – 415, material costs – 180, food taxes – 18, subsidies – 7.

3. Calculate the value of the country's net export, if it is known that the components of GDP are (conventional units): consumer spending – 87,

government spending – 35, net investment – 15, transfers – 5, depreciation – 7. The country's GNI represented 129 conventional units and the net foreign factor income earned abroad – 7 conventional units.

4. In the base year, the country's nominal GDP amounted to €287 billion, and real GDP – €218 billion. Calculate the magnitude and the absolute increase in real GDP in the current year if it is known that the GDP deflator has increased by 11 %, and the nominal GDP will increase to €315 billion.

5. This year, the country's nominal GDP is €219 billion, the GDP deflator is 117 %. Calculate the nominal GDP growth rate and the real GDP growth rate in the current year if it is known that in the base year the nominal GDP amounted to €179 billion, and the GDP deflator was 110 %.

### **Questions for self-assessment**

1. Name and explain the main macroeconomic indicators.
2. How is gross national product determined?
3. List the macroeconomic indicators of the system of national accounts.
4. What are the two main ways of calculating GDP?
5. Write down and explain the formula for calculating GDP based on expenditure.
6. What do consumption costs, investment costs, government spending include?
7. Write down the formula for calculating GDP based on income.
8. What are the sources of each of the types of income in the economic system?
9. How is nominal GDP determined?
10. Describe the real GDP.

### **Review questions**

1. What is the difference between the SNA "double count" and "double entry" methods?
2. Analyze and explain the examples of the distinguishing features of the SNA and SBNE.
3. Explain the nature of the processes of inflation and deflation.

4. What is the qualitative and quantitative difference between GDP and GNI?
5. Describe the basic methods for calculation of GDP.
6. What macro indicator can be used to determine the entire income of a country which can be controlled by the national economy?
7. What is a non-observed economy?
8. What is the difference between intermediate and final goods and services?
9. Describe macro indicators on a net basis.
10. Compare the concept of personal income and disposable income.

### **Tests**

1. The value of the real GDP of a country does not grow if the following is observed:
  - a) an increase in the labour force;
  - b) an increase in the volume and technical level of equipment;
  - c) inflation growth;
  - d) improvement of production technology.
2. Which statement is incorrect?
  - a) The SNA does not use double counting and double recording.
  - b) Real GDP is calculated using base prices.
  - c) The recipient of transfer payments must compensate them.
  - d) National wealth refers to indicators of stocks.
3. How will the GDP and GNI of Ukraine change if a company from the Czech Republic builds a new entertainment complex in Kharkiv region:
  - a) Ukraine's GDP will grow faster than GNI;
  - b) Ukraine's GDP will grow more slowly than GNI;
  - c) both GDP and GNI of Ukraine will grow at the same pace;
  - d) there is not enough data for the correct answer.
4. Which of the following statements are correct?
  - a) The consumer price index does not include the price of imported goods and services.
  - b) The GDP deflator is calculated based on the consumer basket in the base period.
  - c) The consumer price index reflects only changes in the level of prices for consumer goods and services.
  - d) All answers are incorrect.

5. Which of the following is not included in GDP:

- a) public procurement of goods and services;
- b) deductions for the consumption of fixed capital;
- c) state transfer payments;
- d) subsidies?

6. If the volume of real GNI decreased by 6 % and the population in the same year decreased by 3 %, then:

- a) real GNI per capita decreased;
- b) real GNI per capita increased;
- c) real GNI increased, while nominal GNI decreased;
- d) prices fell by 3 %.

7. Value added (gross value added) is:

- a) the market value of all goods and services produced in the country in the year;
- b) gross output in monetary terms minus intermediate consumption;
- c) the difference between the revenue from sales and the cost of material costs;
- d) the difference between revenues from factors of production from abroad and the factor incomes received by foreign investors in the country.

8. The difference between GNI and GDP is:

- a) the factor income from abroad;
- b) the transfer payments to the household sector from abroad;
- c) the difference between the revenue from sales and the cost of material costs;
- d) the difference between the receipts from the national factors of production from abroad and the factor incomes received by foreign resources in a certain country.

9. Inflation of GDP is the adjustment of nominal GDP in the direction of:

- a) reduction if the deflator is less than one;
- b) decrease if the deflator is more than one;
- c) increase if the deflator is less than one;
- d) increase if the deflator is more than one.

10. Deflating GDP is the adjustment of nominal GDP to:

- a) a decrease if the deflator value is more than one;
- b) a decrease if the deflator value is less than one;
- c) an increase if the deflator value is greater than one;
- d) an increase if the deflator value is less than one.

Answers: 1c; 2a, c; 3a; 4d; 5c, d; 6a; 7b, c; 8d; 9c; 10a.

### 3. Labor market

The purpose of the topic is to form students' knowledge of the analysis of the labor market mechanism, and develop skills in determining the levels of employment and unemployment.

The market economy is formed and developed as organic unity of many markets: capital, land, housing, goods, services, labor, etc. The labor market has a special impact on the functioning of the economy which is constantly in view of the state, since the reproduction of such commodity as workforce is the reproduction of labor and productive forces of society in general.

The labor market is an integral part of the economy as a whole market mechanism. It is the labor market that should promote a more rational use of the labor potential of the country, effective regulation of the movement of unemployed labor force. It becomes a kind of arena for improvement of the quality of staff.

Therefore, we must first create a macroeconomic environment based on social, organizational and legal measures that hamper the development of negative processes in the field of employment.

3.1. Employment and unemployment.

3.2. Labor market and the mechanism of its functioning.

3.3. State regulation of employment.

**Key terms:** labor market, market economy, labor, labor force, employment, unemployment, labor supply, labor demand, state regulation of employment, state employment policy.

#### 3.1. Employment and unemployment

In foreign statistics, the entire population of a country can be conditionally divided into two groups:

1. Economically inactive population or people who do not belong to the labor force. This group includes: children under the age of 15 years (students); pensioners; housewives; people without a fixed place of residence; people serving sentences in specialized institutions; people held in psychiatric institutions; disabled people; people who have stopped searching for work.

2. Economically active population (labor force) includes employed and unemployed people.

Employment is the activity of the population related to the satisfaction of their own and social needs.

The employed are people who have any paid work (it does not matter if they are employed full time or part time or a week), as well as people who have work but do not work due to vacation, illness, a strike or natural disaster.

In Ukraine, the category of employed includes citizens who: legally live in the country and have full-time or part-time jobs in institutions of all forms of ownership, in international and foreign organizations in Ukraine and abroad; independently provide themselves with work; work in paid positions in the government, administration and public organizations; serve in the Armed Forces of Ukraine, the National Guard of Ukraine as well as in other military units created in accordance with the legislation of Ukraine, and in alternative (non-military) service; undergo professional training, retraining and advanced training separate from work; study at full-time departments in secondary schools and higher educational institutions, as well as working citizens of other countries who temporarily stay in Ukraine and perform functions unrelated to the support of embassies and missions. (The Law of Ukraine "About Employment" dated March 1, 1991 No. 803-XII).

Legally established working age in Ukraine is from 15 to 70 years.

Unemployment is a socio-economic phenomenon in the labor market characterized by the fact that part of the economically active population is not employed in the production process.

In accordance with the methodology of the International Labor Organization the unemployed are people who do not have paid work, actively look for work or try to organize their own business over the past four weeks, ready to get started in the next two weeks.

Citizens who are not recognized as unemployed are people under the age of 15 years, except for those who have already worked and have been dismissed in accordance with the law; people looking for a job for the first time and having no profession; those who refused two job offers from the moment of their registration with the employment service.

In Ukraine, in order to obtain unemployment status, it is necessary to register with the employment service. Labor force is calculated as follows:

$$\text{Labor force} = \text{employed} + \text{unemployed}. \quad (3.1)$$

There are some main types of unemployment.

*Frictional unemployment* is a type of unemployment that takes place when workers are searching for new working places or are transitioning from one job to another. It is a part of natural unemployment and it exists even when the economy is considered to be in a state of full employment. Frictional unemployment is most often identified with a job search or expectation. Frictional unemployment enables a person, on the one hand, to find more favorable conditions for his life, and on the other hand, reflects the progressive processes that occur in the economy and in society as a whole.

*Structural unemployment* is associated with technological shifts in production that change the structure of labor demand [1, p. 48]. It arises if the supply and demand for labor do not coincide and the correspondence between these indicators for different types of labor and different regions and sectors of the economy is not the same. After a certain period some changes take place in the structure of consumer demand and in production technology and this leads to changes in the structure of labor demand. This type of unemployment is caused by the fact that the structure of the workforce does not match the structure of jobs. On the one hand, new jobs are appearing, and on the other hand, there is a surplus of obsolete workers.

A feature of structural unemployment is that, firstly, the unemployed have to retrain and go through professional training and, secondly, unemployment itself is predominantly of the forced and long-term nature.

Frictional and structural unemployment are inevitable and even desirable for the economy because they contribute to a more rational distribution of labor and higher growth of labor productivity.

In 1968 the economists M. Friedman and E. Phelps independently from each other, based on the analysis of frictional and structural unemployment, created the theory of full employment and the natural level of unemployment.

Full employment is a situation in the economy when the share of unemployed is 5 – 7 % of the total labor force. These indicators may vary



depending on countries and over time but in all cases full employment of the labor force does not mean its full use.

The natural rate of unemployment is the full-time unemployment rate corresponding to potential GDP or it is a steady unemployment rate that stabilizes inflation.

So, the natural rate of unemployment is the unemployment rate that would exist in a flourishing and growing economy. In other words, the natural rate of unemployment includes only frictional and structural unemployment, and does not consider cyclical unemployment:

$$u^* = u_F + u_S, \quad (3.2)$$

where  $u^*$  is the natural unemployment rate;

$u_F$  is the level of frictional unemployment;

$u_S$  is the level of structural unemployment.

The key indicators of the labor market are:

1) the unemployment rate ( $u$ ):

$$u = U / L \times 100 \% \quad \text{or} \quad u = U / (E + U) \times 100, \quad (3.3)$$

where  $U$  is the number of unemployed;

$E$  is the number of employees;

$L$  is the labor force;

2) the level of employment ( $e$ ):

$$e = E / \text{adult} \times 100 \%, \quad (3.4)$$

where  $\text{adult}$  is the number of adults employed;

3) the frictional unemployment rate ( $u_F$ ):

$$u_F = U_F / L \times 100 \%, \quad (3.5)$$

where  $U_F$  is the number of frictional unemployed;

4) the structural unemployment rate ( $u_S$ ):

$$u_S = U_S / L \times 100 \%, \quad (3.6)$$

where  $U_S$  is the number of structural unemployed;

5) the actual unemployment rate ( $u_A$ ):

$$u_A = u_F + u_S + u_C, \quad (3.7)$$

where  $u_C$  is the level of cyclical unemployment;

$$u_A = (U_F + U_S + U_C) / L \times 100 \%, \quad (3.8)$$

where  $U_C$  is the number of cyclical unemployed;

$$u_A = u^* + u_C; \quad (3.9)$$

$$u_A = (U^* + U_C) / L \times 100 \%, \quad (3.10)$$

where  $U^*$  is the number of natural unemployed;

6) the cyclical unemployment rate ( $u_C$ ):

$$u_C = U_C / L \times 100 \%; \quad (3.11)$$

$$u_C = u_A - u^*; \quad (3.12)$$

7) the natural unemployment rate ( $u^*$ ):

$$u^* = u_A - u_C. \quad (3.13)$$

Natural unemployment is an indicator of full employment. If actual unemployment equals natural unemployment, the economy is in a state of full employment. If actual unemployment exceeds the natural one, this indicates that there is underemployment caused by a shortage of jobs. Under conditions of underemployment, the demand for labor is less than its supply, which creates cyclical unemployment.

Under conditions of excess demand in the labor market, the number of those who are looking for work is less than the number of free jobs, so excessive employment occurs and therefore actual unemployment is lower than natural unemployment.

The main social consequences of unemployment include the following:

loss of qualifications and practical skills;

increase in crime and aggravation of the criminal situation in the country;

prolonged depression leading to an increase in the number of suicides, mental and cardiovascular diseases;

increase in alcoholism and drug addiction;

exacerbation of social tension in society which can lead to significant political and social changes in society;

increasing marginalization of society [2, p. 33].

The economic consequences of unemployment can be quantified using Okun's law: if the actual unemployment rate is 1 % higher than the natural one, then the actual output will be  $\beta$  % lower than the potential one (the GDP gap):

$$\text{GDP gap} = -\beta (u_F - u^*), \quad (3.14)$$

where  $\beta$  is the empirical coefficient of sensitivity of GDP to the dynamics of cyclical unemployment (Okun's coefficient).

The coefficient  $\beta$  is established empirically and therefore may vary for different countries. As a rule, its values are in the range from 2 to 3 but by default it is taken equal to 2.5.

Using this formula you can calculate the gap in GDP as a percentage of potential GDP.

Potential GDP is the volume of real GDP that the economy produces under conditions of full employment and a natural level of unemployment.

In a formalized form, Okun's law can be written in the form of the following formulas:

$$(Y - Y^*) / Y^* = -\beta (u_A - u^*), \quad (3.15)$$

and

$$(Y - Y^*) / Y^* = -\beta u_C, \quad (3.16)$$

where  $Y$  is the actual volume of domestic production (GDP);

$Y^*$  is the potential volume of domestic production (GDP).

Based on these formulas, you can calculate the potential GDP ( $Y^*$ ) and the GDP loss from cyclical unemployment ( $\Delta Y$ ) in value terms:

$$\Delta Y = Y - Y^*. \quad (3.17)$$

### 3.2. Labor market and the mechanism of its functioning

Labor market, also known as job market, refers to supply and demand for labor where employees provide the supply and employers form the demand. It is a major component of any economy intricately tied with markets of capital, goods and services.

Labour market is the place where workers and employees interact with each other. In the labour market, employers compete to hire the best, and workers compete for the best satisfying job.

Labour market in an economy functions with demand and supply of labour. In this market, labour demand is the firm's demand for labour and supply is the worker's supply of labor. The supply and demand of labor in the market is influenced by changes in the bargaining power.

Labor market is a set of economic relations concerning the sale of a specific commodity – labor.

There are two types of labor market in macroeconomics. They are: the national and global labor markets. The national labor market operates in the economy of a country as a whole. The world labor market operates on a global scale and exists in the form of labor migration.

Similar to any market, labor demand and supply are formed in the labor market (Fig. 3.1).

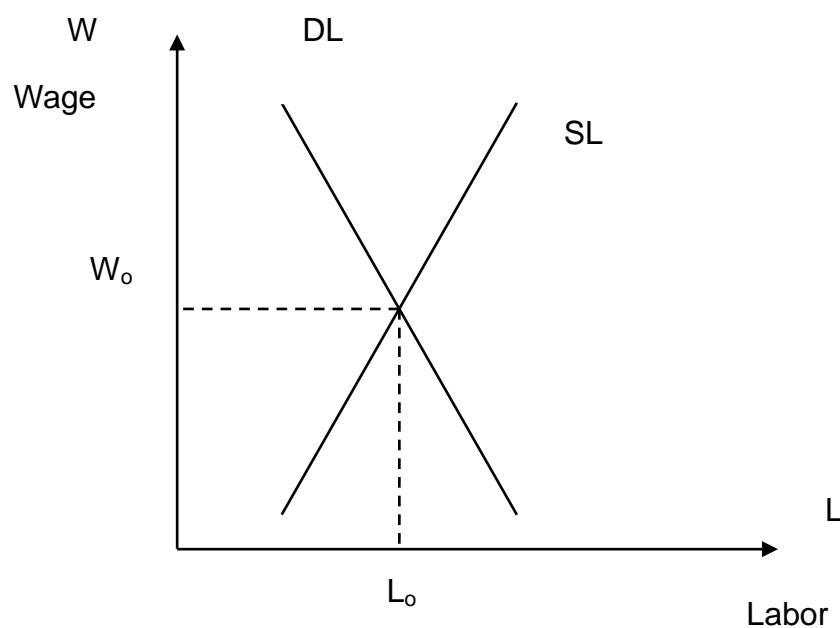

Fig. 3.1. Supply and demand in the labor market

The demand curve has a negative slope, as it reflects the law of downward marginal labor productivity. The supply curve has a positive slope since with the growth of wages the supply in the labor market also increases. The intersection of the supply and demand curves gives an equilibrium wage level  $W_0$ . At this level of wage, a full-time  $L_0$  is set in the economy. If wages are below this level, then demand exceeds supply and there are not enough workers at enterprises.

In order to attract additional workers, enterprises increase wages. If wages exceed the equilibrium level, then supply exceeds demand (unemployment). Therefore, entrepreneurs will be able to fill vacancies offering lower wages.

#### **Interesting to know**

Labor supply is formed under the influence of the following factors:  
demographic;  
the level of economic activity of the population;  
the retirement age adopted in the country;  
immigration of the working-age population;  
the involvement of women in the labor process;  
working hours activities of trade unions, etc.

Demand for labor is formed under the influence of such basic factors as: demand for goods and services produced with the help of workers; salary level; degree of substitutability in the technological process of capital for labor; phases of the business cycle; scientific and technological progress, etc.

The main product that is sold in the labor market is the labor force, thus there is no single definition of it. The labor force in various theories is: the ability of a person to work; a combination of physical and mental abilities of the person who uses them during the production of vital goods; part of the population, including employed, self-employed and job seekers (unemployed).

The specificity of the product "labor force" is that it is a product that is: alive commodity purchase of which is called the hiring; in the process of sale is not alienated from its owner.

The seller sells only his ability to work and only for a certain time, while remaining the owner and carrier of this product; and the buyer and seller in the process of sale are legally equal persons, socially protected both by the state and by trade unions; labor cannot be saved like any other product; it is

not destroyed in the process of use but on the contrary, is multiplied and takes part in the creation of other goods and services.

#### **Interesting to know**

The main functions of the labor market are:

- 1) economic – ensuring the optimal process of reproduction of the able-bodied population;
- 2) social – ensuring a high standard of living and quality of workers and their families.

In economic theory, the mechanism of the functioning of the labor market is explained in different ways. Most often, the following basic concepts are considered.

The neoclassical theory proceeds from the fact that there is perfect competition in the labor market with absolutely flexible wages, and the criterion of demand for labor from enterprises is the maximization of profits. This means that any enterprise will increase the demand for labor until the increase in its expenses on labor remuneration exceeds the growth in revenue from the sale of the product.

Profit maximization is ensured if marginal labor productivity equals marginal labor costs (i.e., the cost of wages per employee). Under conditions of maximizing profits, the demand for labor is inversely dependent on real wages, therefore it is a downward function of real wages [3, p. 30].

At the same time, despite a decrease in real wages, enterprises will not increase demand for labor unless demand for their products grows at the same time, i.e. the demand for labor also depends on the real product (direct correlation). Labor supply also depends on real wages: the higher the wages, the greater the supply of labor.

The reason for unemployment is excessive wages, which exceed the equilibrium value prevailing in the market. This neo-classical unemployment is considered a temporary phenomenon as wages quickly eliminate imbalances in the labor market. First, real wage growth reduces demand in the labor market. Under these conditions, competition will force workers to agree to a reduction in nominal wages.

It will go down as long as real wages do not reach a level that will be followed by the approach of supply and demand to the equilibrium value. If a

certain part of the workers does not agree to work on a lower wage, then such unemployment is considered voluntary according to neoclassical theory.

Keynesian theory is based on other prerequisites. Justifying the demand for labor, the Keynesians do not take into account the wage because they believe it inflexible in the short term. Demand for labor depends on aggregate demand i.e. aggregate demand determines not only the volume of production that will be produced in the economy but also the amount of labor necessary for production.

Marginal labor productivity is used to determine the upper limit of wages to which employers agree when concluding agreements with workers. Keynesians, unlike the classics, rely on nominal (rather than real) wages. With an increase in nominal wages the supply of labor increases. In Keynesian theory the occurrence of unemployment is not explained by excessive wages but by a shortage in aggregate demand.

The fundamental differences between neoclassical and Keynesian theory is that in Keynesian theory only demand is a function of nominal wages; wages cannot change downward, because they do not respond to insufficient demand for labor, therefore, labor supply cannot decrease to an equilibrium level and labor demand cannot increase to an equilibrium level (it is a function of aggregate demand).

Thus, the wages are not able to balance the short-term labor market and ensure the achievement of full employment, i.e. the economy may be in a state of underemployment until the aggregate demand increases. To control unemployment, Keynesians suggest using a government policy to stimulate the aggregate demand.

Flexible labor market. At the end of the 20th – beginning of the 21st centuries, due to transitional processes, there was a growth of the so-called flexibility in the labor market. Unlike the neoclassical or Keynesian concept of the labor market which provides a balance in the recession phase by reducing employment or wages, the flexible market concept provides a number of socio-economic, organizational and legal measures to quickly adapt business entities to new conditions.

The main features of a flexible labor market are: non-standard forms of employment; flexible forms of employment; stimulation of all forms of labor mobility, including territorial and international labor migration; development of various forms of vocational training and retraining of workers, etc.

### 3.3. State regulation of employment

The state policy of regulation of employment can be divided into two main types: active and passive.

Active policy is a set of methods aiming to create the conditions for the quickest return of unemployed to active work. It includes measures for: creating additional areas of employment; training, retraining and advanced training of personnel; increased labor mobility; assistance in finding employment, etc.

Using a passive policy the state takes responsibility for the state of workers and employers in the labor market. It includes the payment of funds to partially compensate the unemployed for their loss in income. This is registration of the unemployed at labor exchanges or employment services; setting the size of unemployment benefits; organization of unemployment benefits, etc.

The employed are guaranteed preservation of jobs, payroll, social insurance, etc. by passive policy. Employers are guaranteed demand for the planned volume of production; provision of raw materials; price stability and targeted financing.

In the short term, there is an inverse relationship between inflation and unemployment, which is determined by the Phillips curve [3, p. 34].

The essence of the Phillips curve is a reflection of the inverse relationship between the rate of price growth and the rate of growth of unemployment. Fig. 3.2 shows the Phillips curve in the short term: the lower the unemployment rate ( $u_A < u_B$ ) and the higher the employment, the higher the inflation rate ( $\pi_A > \pi_B$ ).

The graph shows that the choice of a certain combination of inflation and unemployment rates depends on the target function of economic policy which is given by the state preference curve GG. The point of intersection between the short-term Phillips curve and the government preference curve shows the optimal values of the rate of inflation ( $\pi_E$ ) and unemployment ( $u_E$ ).

Modern critics of Keynes's theory by analyzing the Phillips curve have come to the conclusion that it works only in the short run. In the long run, the relationship between price movements and employment has a different shape (Fig. 3.3).



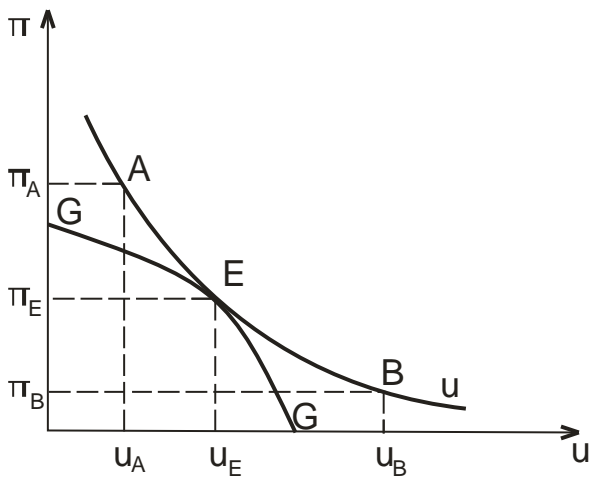

Fig. 3.2. The Phillips curve in the short run

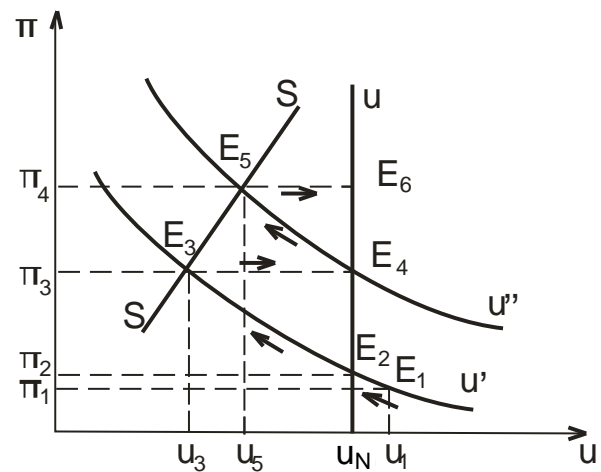

Fig. 3.3. The Phillips curve in the long run

The long-term equilibrium in the labor market is represented with the level of natural unemployment ( $u_N$ ) by the vertical line  $u$  which is crossed by the short-term Philips curves  $u'$  and  $u''$  for different values of the actual inflation rate. Suppose the economy is characterized by a point  $E_1$  with the inflation rate  $\pi_1$  and the level of unemployment  $u_1$ .

Unemployment exceeds the natural level and is forced. When the economy is in such a state, government intervention is entirely justified. Using the tools of macroeconomic policy the government reaches a reduction of unemployment to the level of  $u_N$ . However, these tools are those that make the inevitable short-term increase in the rate of inflation to  $\pi_2$ .

In the situation indicated by point  $E_2$ , a natural unemployment rate is achieved. Nevertheless, the state can continue macroeconomic regulation of the labor market, reducing unemployment to  $u_3$ , which is much lower than the natural level. But at the same time, the inflation rate rises to  $\pi_3$ . At the same time, there will be an increase in adaptive inflationary expectations of workers, accompanied by demands for an increase in nominal and real wages.

Since such an increase in wages is inflationary in nature and is determined by the economic policy of the state, the labor market will be unbalanced and a natural movement will begin in the direction of establishing equilibrium. Taking into account the high wage rates entrepreneurs will begin reducing the number of workers, afterwards unemployment will increase and the economy will move from point  $E_3$  to point  $E_4$ . The natural unemployment rate will be achieved again but with a higher inflation rate  $\pi_3$ . That is, the

active actions of the state will lead only to a short-term reduction in unemployment and to a rapid increase in inflation. So, trying to establish full employment, the state can achieve only a short-term reduction in unemployment, afterwards its growth will again be observed on a higher level. If the state continues to pursue such policy in the long run, a negative economic phenomenon of stagflation (SS curve) will occur – a simultaneous increase in unemployment and inflation.

Thus, we can conclude that in the long term monetarists suggest persuasive policy of state regulation of the labor market only when the actual unemployment rate is higher than the natural one. If the regulation of the labor market by the state continues when the actual unemployment rate falls below the natural level, it means that stagflation will occur.

### **Inference**

Labor market is a place where there is supply and demand for jobs where workers or the workforce provide the services that are required by employers. An employee can be anyone who wants to offer their services for a fee while an employer can be a separate legal entity or organization that needs a person to perform a specific job or to complete a task. Then the employee is comparable to the seller, and the employer is the buyer.

Labor market analysis is an integral part of the organization's recruitment process, as it does not only help find the most qualified employees for the jobs it offers but also ensures that it provides a competitive compensation package to its employees. This is important in order that an organization can keep its competent employees and, thus, continue its productivity.

The main product that is sold in the labor market is the labor force, thus there is no single definition of it. The labor force in various theories is: the ability of a person to work; a combination of physical and mental abilities of a person who uses them during the production of vital goods; part of the population, including the employed, the self-employed and job seekers (the unemployed).

Under conditions of excess demand in the labor market, the number of those who are looking for work is less than the number of free jobs. Under these conditions, excessive employment occurs and therefore actual unemployment is lower than the natural one.

The main social consequences of unemployment include the following: loss of qualifications and practical skills; increase in crime and aggravation of the criminal situation in the country; prolonged depression leading to an increase in the number of suicides, mental and cardiovascular diseases; increase in alcoholism and drug addiction; exacerbation of social tension in society which can lead to significant political and social changes in society; increasing marginalization of society.

## Glossary

**Labor market** is a set of economic relations concerning the sale of a specific commodity – labor.

**Employment** is the activity of the population related to the satisfaction of their own and social needs.

**The employed** are people who have any paid work (it does not matter if they are employed full time or part time or a week), as well as people who have work but do not work due to vacation, illness, a strike or natural disaster.

**Unemployment** is a socio-economic phenomenon in the labor market, when part of the economically active population is not employed in the production process.

**Frictional unemployment** is a type of unemployment that takes place when workers are searching for new working places or are transitioning from one job to another. It is a part of natural unemployment and it exists even when the economy is considered to be in a state of full employment.

**Frictional unemployment** is most often identified with a job search or expectation. Frictional unemployment enables a person, on the one hand, to find more favorable conditions for his life, and on the other hand, reflects the progressive processes that occur in the economy and society as a whole.

**Structural unemployment** is associated with technological shifts in production that change the structure of labor demand.

**Natural rate of unemployment** is the unemployment rate that would exist in a flourishing and growing economy.

**Okun's law:** if the actual unemployment rate is 1 % higher than the natural one, then the actual output will be  $\beta$  % lower than the potential one (the GDP gap).

## Questions for self-assessment

1. Give a definition of unemployment.
2. Give examples and show the difference between economically active and economically inactive population.
3. What are the main types of unemployment that determine the main indicators in the labor market?
4. What is the difference between the commodity "labor" and other types of commodities?
5. What are the main factors that determine the equilibrium in the labor market?
6. Analyze the mechanism of functioning of the labor market according to the neoclassical concept.
7. Analyze the mechanism of functioning of the labor market according to the Keynesian concept.
8. What is the essence of the concept of a flexible labor market?
9. Is there a difference between the concepts of full employment and natural unemployment rate?
10. What is the fundamental difference between active and passive policies of state regulation in the labor market?

## Practical tasks

1. Assume that in a particular year, the natural rate of unemployment is 5 % and the actual rate of employment is 9 %. Using Okun's Law, determine the size of the GDP gap in % point terms. If the potential GDP is \$500 billion in that year, how much output is being forgone because of cyclical unemployment?
2. Define unemployment and discuss its impact on individuals and families. Justify the answer.
3. The number of unemployed is 10 million people; the number of employed is 140 million. Calculate the labor force and the rate of unemployment.

## Tests

1. Full employment involves:
  - a) lack of cyclical unemployment;
  - b) lack of unemployment;

- c) 100 % employment;
- d) equilibrium in the labor market;
- e) lack of equilibrium in the labor market;
- f) all answers are correct.

2. If a person quits his job on his own, unemployment is:

- a) frictional;
- b) structural;
- c) cyclic;
- d) natural;
- e) actual;
- f) real.

3. The natural unemployment rate is defined as the sum (difference) of the following types of unemployment:

- a) actual – cyclical;
- b) frictional – structural;
- c) frictional + cyclic;
- d) all answers are correct;
- e) all answers are incorrect.

4. Frictional unemployment is:

- a) a type of unemployment that takes place when workers are searching for new working places or are transitioning from one job to another;
- b) a part of natural unemployment that exists even when the economy is considered to be in a state of full employment;
- c) most often identified with a job search or expectation;
- d) enables a person, on the one hand, to find more favorable conditions for his life, and on the other, reflects the progressive processes that occur in the economy and society as a whole;
- e) all answers are correct;
- f) all answers are incorrect.

5. Structural unemployment:

- a) is associated with technological shifts in production that change the structure of labor demand;
- b) exists even when the economy is considered to be in a state of full employment;
- c) is a type of unemployment that takes place when workers are searching for new working places;
- d) all answers are correct;
- e) all answers are incorrect.

6. Natural unemployment:

- a) is an indicator of full employment;
- b) is underemployment caused by a shortage of jobs;
- c) frictional + cyclic;
- d) all answers are correct;
- e) all answers are incorrect.

7. The main features of a flexible labor market are:

- a) non-standard forms of employment;
- b) flexible forms of employment;
- c) stimulation of all forms of labor mobility, including territorial and international labor migration;
- d) all answers are correct;
- e) all answers are incorrect.

8. The state policy of regulation of employment can be divided into two main types:

- a) active and passive;
- b) normative and positive;
- c) natural and actual;
- d) all answers are correct;
- e) all answers are incorrect.

9. With the natural unemployment rate:

- a) actual GDP is greater than potential GDP;
- b) actual GDP is less than potential GDP;
- c) actual GDP is equal to potential GDP;
- d) all answers are correct;
- e) all answers are incorrect.

10. In accordance with neoclassical theory, the demand for labor is a function of:

- a) nominal salary;
- b) real salary;
- c) aggregate demand;
- d) aggregate supply;
- e) all answers are correct;
- f) all answers are incorrect.

Answers: 1d; 2a; 3a; 4e; 5a; 6a; 7d; 8a; 9c; 10b.

## 4. Commodity market

Demand and supply are the most widespread terms in a modern economic science. The essence of market demand and supply as well as factors influencing them are subjects of study of economic theory and microeconomics. This section provides an insight into the difference between market and aggregate variables; describes price and nonprice determinants of aggregate demand and aggregate supply, compares and contrasts classical and Keynesian models of aggregate supply in the short and long run.

It also focuses on the AD – AS model as the basic model of macroeconomic equilibrium, examines how aggregate demand and aggregate supply equilibrate and how breaking of macroeconomic equilibrium caused by either aggregate demand or aggregate supply recover. The information about the "ratchet effect" in the "overheating economy" is also provided.

4.1. Aggregate demand.

4.2. Aggregate supply.

4.3. The equilibrium between aggregate demand and aggregate supply.

**Key terms:** aggregate demand (AD), AD curve, wealth effect, interest rate effect, foreign price effect, aggregate supply, AS curve, short-run aggregate supply (SRAS), long-run aggregate supply (LRAS), Keynesian zone, intermediate zone, neoclassical zone, general equilibrium, long-run equilibrium, AD – AS model, equilibrium point, sticky prices, price shocks, demand shocks, supply shocks.

### 4.1. Aggregate demand

Aggregate demand (AD) is the size of the total spending of key macroeconomic agents (households, enterprises, government and the rest of the world) on domestic goods and services at each price level. Sometimes modern scholars use the term "total planned expenditure" for aggregate demand. It includes four components of GDP (consumption, investment,

government purchases of goods and services, net export) and mathematically can be described as:

$$Y = C + I + G + NE, \quad (4.1)$$

where Y is aggregate demand;

C is households' demand;

I is enterprises' demand;

G is government's demand;

NE is net export.

Let's briefly describe the components making up aggregate demand in the economy as a whole. In the most general sense, households' demand is the planned households' spending on consumer and investment goods and services. The structure of households' spending is usually the following:

1) spending on durable goods:

a) spending on furniture (tables, chairs, bookcases, dining and coffee desks;

b) spending on consumer electronics (or "brown goods") such as computers, TVs, digital media players, game consoles, mobile phones, other smart devices;

c) spending on major appliances (or "white goods") such as refrigerators, washing machines, drying machines, vacuum cleaners, ovens;

d) spending on small appliances such as mincing machines, blenders, toasters, coffee makers, hair dryers;

2) spending on consumer goods such as food, clothing, footwear, beverages, soft drinks, stationery, tablets, accessories, books;

3) spending on consumer services such as education, health care, insurance, traveling, culture, consulting, leasing, cleaning, plumbing and heating services.

Enterprises' demand is incentives or even plans of businesses to invest in tangible and intangible assets in order to produce a greater quantity of output. Strictly speaking, it is the total investment in the country. Enterprises' demand consists of their demand to invest in buildings, production facilities, capital equipment, plants, machinery, machines, engines, diggers, inventories, railroads, automobiles, buses, stocks.

The government's demand is the government purchases of goods and services that include both purchases of factors of production (capital, labor,



land, information, innovation) from individuals and entrepreneurs as well as final goods from enterprises.

Net export is the difference between aggregate spending of households, enterprises and the government on domestic goods and services and aggregate spending of households, enterprises and the government on foreign goods and services. These concepts have been covered in section 2.

As a rule, households' demand is the major component of aggregate demand. So it is not surprising that the sum of households' spending and enterprises' spending ( $C + I$ ) usually exceeds the sum of the government's spending and net export ( $G + NE$ ). This statement ( $C + I > G + NE$ ) is proved by the data presented in Fig. 4.1.

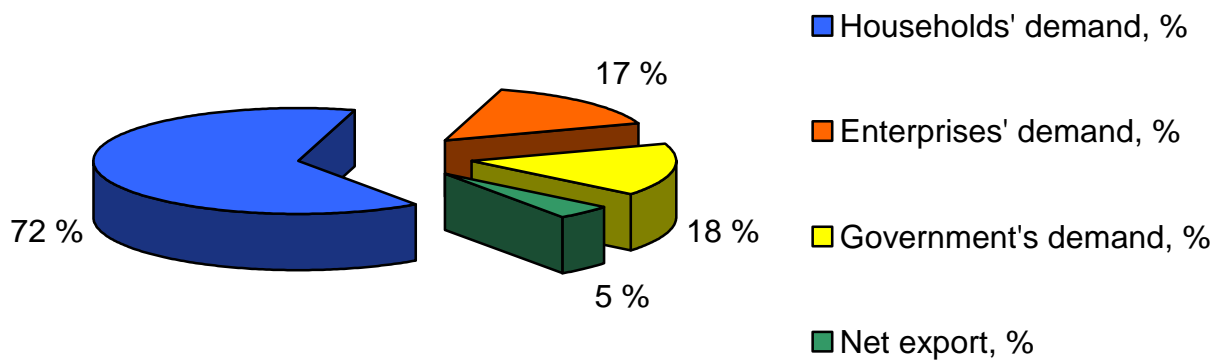

**a) the components of aggregate demand in the United States**

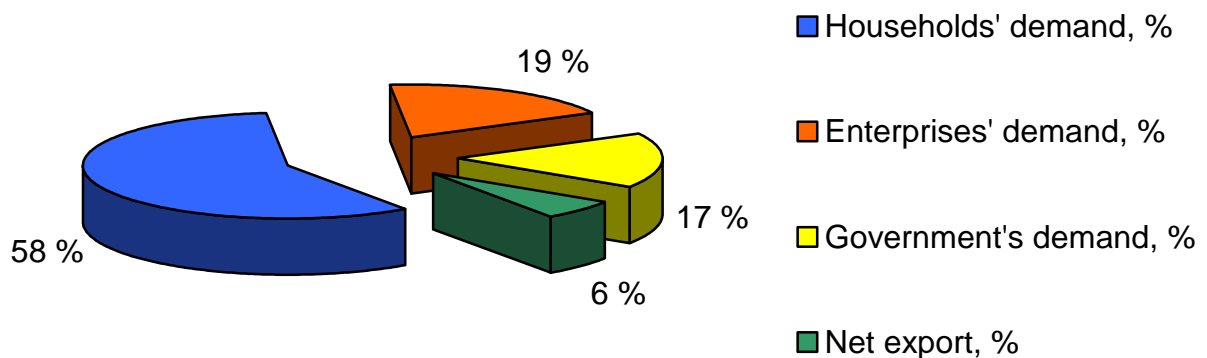

**b) the components of aggregate demand in Ukraine**

**Fig. 4.1. The comparison of the structure of aggregate demand in the United States and Ukraine in 2018**

Fig. 4.1 shows that the sum of households' spending and enterprises' spending exceeds the sum of the government's spending and net export in the United States by 66 %; similarly, the sum of households' spending and enterprises' spending exceeds the sum of the government's spending and net export in Ukraine by 54 %.

Price level is a key factor influencing aggregate demand. Like the relationship between market demand and price of a certain good or service, the relationship between aggregate demand and price level is also negative (Fig. 4.2).

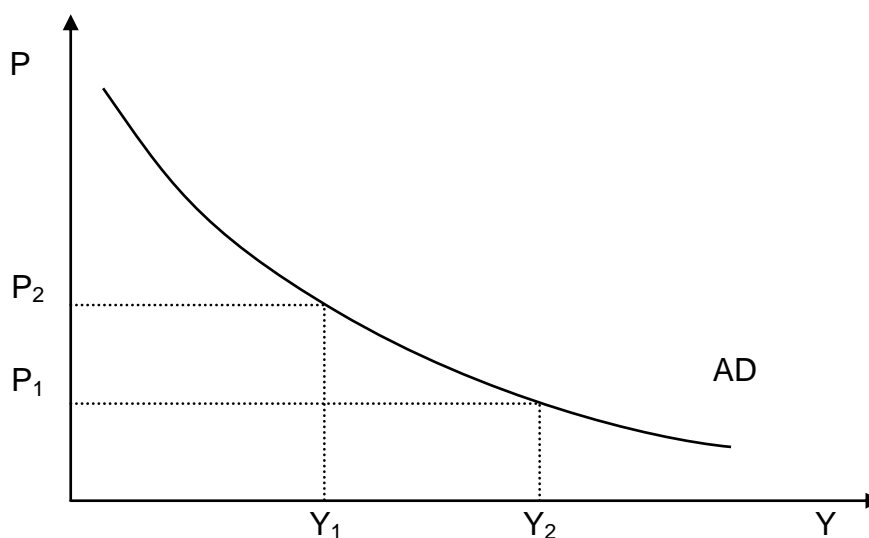

**Fig. 4.2. The aggregate demand curve**

When price level rises (from  $P_1$  to  $P_2$ ), aggregate demand falls (from  $Y_2$  to  $Y_1$ ). Conversely, when price level drops (from  $P_2$  to  $P_1$ ), aggregate demand increases (from  $Y_1$  to  $Y_2$ ).

To begin to use the AD model, it is useful to build the aggregate demand curve based on the hypothetical data:

Aggregate demand, bln euros	500	1 000	1 500	2 000	2 500	3 000
Price level, %	1.4	1.0	0.7	0.5	0.3	0.28

Draw aggregate demand on the horizontal axis and price level (or GDP deflator) on the vertical axis. Obtain Fig. 4.3 that shows the negative relationship between the aggregate demand and the price level in the economy.

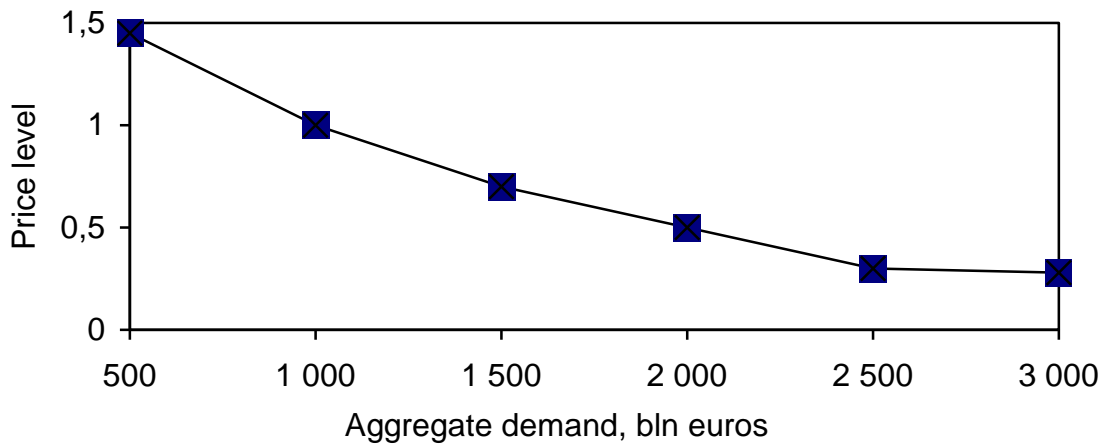

**Fig. 4.3. The aggregate demand curve of the country X**

Fig. 4.2 and 4.3 show that the aggregate demand curve (AD curve) slopes downward fairly steeply. It is explained by three effects: the wealth effect, the interest rate effect and the foreign price effect. Define each of the mentioned effects more precisely.

The wealth effect (or the real-balance effect) was proposed by A. Pigou in the nineteenth century. It means that change in the price level in a country leads to change in the real value of the wealth of a nation. It is caused by the following fact. Wealth mainly consists of households' financial assets such as shares of stock, bonds and bills. Suppose your saving in cash is 2 000 euros. If the price level in the country triples, the real value of your assets (or purchasing power of the assets) will drop by 300 %. Therefore, an increase in the price level results in a decrease in the real value of the wealth of a nation and a fall in aggregate demand. It is graphically shown as the downsloping aggregate demand curve. To make this point more formal, write the following:

$$P \uparrow \rightarrow \frac{M}{P} \downarrow \rightarrow W \uparrow \rightarrow I \downarrow \rightarrow AD \downarrow,$$

where P is the price level;

$\frac{M}{P}$  is the purchasing power of money;

W is the wealth of nation;

I is investment;

AD is aggregate demand.

The interest rate effect was proposed by J. Keynes in the 1930s when he identified that when the price level in the country goes up, the purchasing power of national currency decreases and accordingly the interest rate falls. Because the relationship between the real interest rate and investment demand is negative, the changes result in a decrease in investment in the overall economy. In turn, the relationship between the interest rate and households' demand is also negative because many people borrow money from financial institutions (commercial banks, thrifts, insurance companies, collective investment institutions, mutual fund companies, pension funds and securities firms) to buy durable goods. Besides, when the price level rises, people have to sell their securities to get more money. It is fully logical that an increase in the money supply lowers the prices of financial assets and, therefore, the interest rate rises. For example, the price of a bond is 150 UAH and the interest income is 15 UAH per year. So the interest rate of the asset is 10 % ( $i = \frac{15 \text{ UAH}}{150 \text{ UAH}} \cdot 100 = 10$ ). If the price of the asset drops to 120 UAH, then interest rate will rise and in our case it will be 12.5 % ( $R = \frac{15 \text{ UAH}}{120 \text{ UAH}} \cdot 100 = 12.5$ ). Conversely, if the price of the bond goes up to 170 UAH, then the interest rate will decrease by 1.2 % and will be 8.8 % ( $i = \frac{15 \text{ UAH}}{170 \text{ UAH}} \cdot 100 = 8.8$ ). To make this point more formal, write the following:

$$P \uparrow \rightarrow \frac{M}{P} \downarrow \rightarrow i \downarrow \rightarrow I \uparrow \rightarrow AD \uparrow,$$

where P is the price level;

$\frac{M}{P}$  is the purchasing power of money;

i is the interest level;

I is investment;

AD is aggregate demand.

The foreign price effect was proposed by R. Mundell and M. Fleming in the middle of 1990s. These macroeconomists tried to examine how changes in prices of foreign goods and services influence aggregate demand and total spending in the country. To meet this goal, they analyzed empirical data from

the American economic history during 1950 – 1980s and concluded: when the price level in the country goes up, consumer demand for foreign goods and services in that country increases because they become cheaper compared with domestic products. Because prices of domestic goods and services are higher, foreigners also decrease demand for them. In short, export will decrease, import will increase, net export will also decrease, which results in a fall in aggregate demand and aggregate expenditure. To make this point more formal, write the following:

$$P \uparrow \rightarrow D_n \downarrow \rightarrow D_f \uparrow \rightarrow NE \downarrow \rightarrow AD \downarrow,$$

where P is the price level;

$D_n$  is prices of domestic goods and services;

$D_f$  is demand for foreign goods and services;

NE is net export;

AD is aggregate demand.

There are many non-price-level determinants influencing aggregate demand and shifting the AD curve either rightward (from  $AD_1$  to  $AD_3$ ) or leftward (from  $AD_1$  to  $AD_2$ ) which is shown in Fig. 4.4.

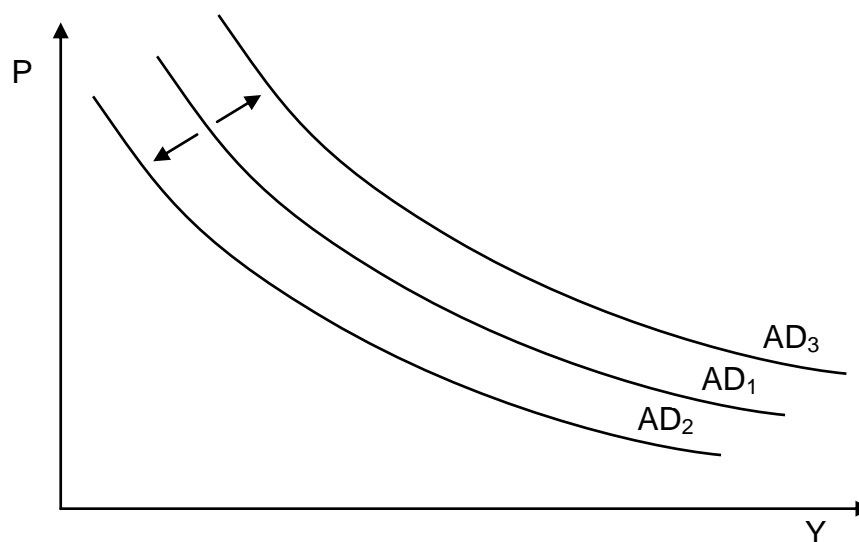

**Fig. 4.4. The influence of nonprice determinants on the aggregate demand curve**

Determine more precisely how changes in the components of aggregate demand influence the AD curve. At the outset, clear up how changes in

consumption influence aggregate demand and shift the AD curve. When households' income rises, they buy more goods and services, so consumption in the country increases and the AD curve shifts rightward; when households' income falls, they have to reduce consumption, consequently the AD curve shifts leftward. Similarly, when households have a pessimistic outlook on the future changes in the country or worry about the jobless, they have to purchase fewer goods and services and the AD curve shifts leftward; when households have an optimistic outlook on the political, economic and social reforms in the future, they increase consumption spending today and, therefore, the AD curve shifts rightward. By the same token, when personal taxes rise, the disposable income of households decreases, so they reduce consumption which results in shifting the AD curve leftward; on the contrary, cutting taxes usually raises the disposable income and the AD curve shifts rightward.

Changes in the investment spending also influence shifting of the AD curve. For example, an increase in money supply leads to a decrease both in the value of money and the interest rate, which stimulates increase in consumption and investment spending. As a result, the AD curve shifts rightward whereas a decrease in money supply leads to an increase both in the value of money and the interest rate, which reduces consumption and investment spending and, therefore, the AD curve shifts leftward. In fact, the relationship between the interest rate and investment demand is negative: when the real interest rate rises, the size of investment declines; when the real interest rate decreases, the size of investment rises.

The government changes aggregate demand by purchasing of goods and services from businesses. Increase in government purchases can relate both to positive and negative domestic changes. The government usually increases aggregate expenditure during a peak or boom in the economy. But the government has to purchase more goods and services during wars and war conflicts. For example, Russia's illegal annexation of Crimea in 2014 and Russian – Ukrainian conflict in the Ukrainian Donbass resulted in the increase in the size of government spending on defense by 6.8 times in 2014 – 2019: from 15.3 bln UAN in 2013 to 102 bln UAN in 2019. It is presented in Table 4.1. It is understandable that increase in government spending leads to the increase in GDP and, therefore, shifts the AD curve rightward; the

decrease in government spending leads to the decrease in GDP and shifts the AD curve leftward.

Table 4.1

**The dynamics of government spending on defense and GDP  
in Ukraine**

Indicators	2013	2014	2015	2016	2017	2018	2019
Government spending on defense, bln UAH	15.3	27	52	59	69	86	102
GDP, bln UAH	1530	1588.24	2 000	2360	2555.56	3440	1895.91

Net export also influences aggregate demand and shifts the AD curve either rightward or leftward. For economy as a whole, a depreciation of national currency leads to the increase in demand for goods and services from abroad because it makes national products cheaper for foreigners. These changes shift the AD curve to the right. Similarly, an appreciation of national currency results in the decrease in demand for domestic output and shifts the AD curve to the left. Besides, policy actions may change net exports by restricting or expanding the entry of foreign goods and services on the domestic market. Other things equal, when the government restricts the entry of foreign goods to the country, imports reduce, net exports rise and the AD curve shifts to the right. An expansion of the entry of foreign goods to the country will have the opposite effects. Truth be told, in today's business world many governments try to protect national markets from foreign competition. For instance, to protect domestic manufacturers from Chinese intervention, D. Tramp, the U.S. President, imposed a 25 % duty on imports of steel, aluminum, washing machines, solar panels, computer equipment and even cars.

Demand shocks are surprise events that lead to an increased or decreased demand for output (case study).

### Case study

#### Historical energy price shocks and their influence on the British economy

Significant demand shocks in the United Kingdom were observed in times of warfare, as they generated unusual and intensified demands for energy resources, in particular woodfuel, provender, coal, oil, gas and primary electricity. The wars that had the most significant impacts on aggregate demand were the War of Spanish Succession in 1704 – 1705 and the Second World War in 1939 – 1945. The Seven Years' War in combination with three simultaneous colonial wars against France (in North-America, India & Ghana) in 1757, the Battle of Waterloo in 1815, the second Boer War in 1900 and the First World War in 1914 – 1918 also appear to have been important. There were also periods of stable economic growth that fed through into pressures on resources, "overheating" and increasing energy prices, culminating in economic downturns, often coinciding with financial crisis.

One must distinguish between positive and negative demand shocks presented in Fig. 4.5.

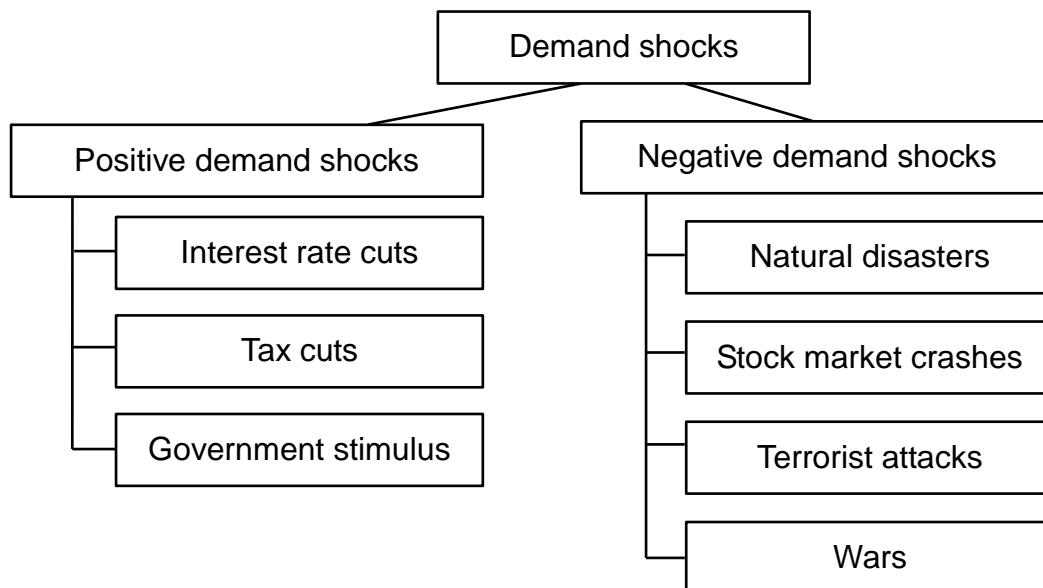

Fig. 4.5. **The causes of positive and negative demand shocks**

Demand shocks usually lead to surging or falling price level as aggregate demand tends to be inelastic in the short run. As time moves forward, the shocks fade and demand responds to find a new, sustainable equilibrium.



## 4.2. Aggregate supply

Aggregate supply (AS) is the output produced and sold in a given period. In other words, aggregate supply is real GDP of the economy. There are price and non-price determinants influencing aggregate supply in the market economy.

Price level is a key factor influencing aggregate supply. The relationship between prices and aggregate supply is positive: when the price level of the output rises, real GDP increases; when the price level of the output falls, real GDP drops. When the actual price level declines from the expected price level, actual output declines from potential output. Keep in mind that price level is the price level under the conditions of full employment. When employers and employees make decisions about the volume of production and nominal wages, they take into account that these decisions should equilibrate labor market and eliminate cyclical unemployment. Hence the aggregate supply function in the short run (SRAS function) can be described as:

$$\text{SRAS} = Y_P + \alpha \times (P - P_E), \quad (4.2)$$

where SRAS is total output in the short run;

$Y_P$  is potential GDP;

$\alpha$  is sensibility of the volume of production to a decline in the actual price level from the expected price level;

$P$  is the actual price level;

$P_E$  is the expected price level (or the price level under conditions of full employment that equilibrates labor market and eliminates cyclical unemployment).

Thus, the SRAS curve shows how actual GDP declines from potential GDP when the actual price level declines from the expected price level by 1 %. Suppose that country Alfa is characterized by the following data: potential GDP is 725 bln euros, sensibility of the volume of production to a decline in the actual price level from the expected price level is 0.75, the actual price level is 115 %, the expected price level is 110 %. Enter the input data in the SRAS function and obtain:  $\text{SRAS} = 725 \text{ bln euros} + 0.75 \times (115 \% - 110 \%) = 728.25 \text{ bln euros}$ .

For the reasons given above, the aggregate supply curve (or the SRAS curve) in the short run slopes up. Unlike the market supply curve, the SRAS

curve consists of three zones: the horizontal zone, the vertical zone and the intermediate zone. It is shown in Fig. 4.6.

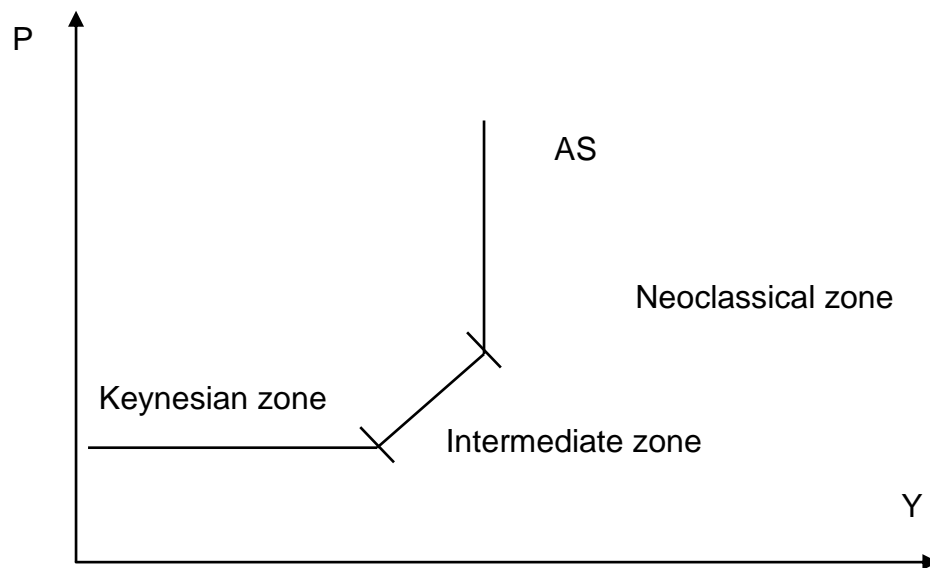

Fig. 4.6. **The aggregate supply curve in the short run**

The horizontal zone of the SRAS curve is often called the Keynesian zone because it was proposed by J. Keynes, an outstanding American economist, who explored the U.S. economy in severe recession and concluded the following: prices were sticky but the national output increased. It can be caused by the following fact. When cyclical unemployment is high, employers agree to freeze wages which allows firms and industries to keep the prices of their goods and services low. Accordingly in the horizontal zone of the SRAS curve, prices are sticky but real GDP constantly increases.

The vertical zone of the SRAS curve is often called the neoclassical zone because it was proposed by neoclassical economists (K. Arrow, G. Debreu, J. Hicks), who took an overall view of the U.S. economy in a boom and investigated that prices were flexible but the total output was constant during 1960s. This implies that in the vertical zone, the economy is near potential (or full-employment) GDP, all businesses are running machinery and equipment at full capacity, cyclical unemployment is relatively low but structural unemployment is a macro issue. That leads to the increase in wages which results in higher prices in the vertical zone.

Only the intermediate zone on the SRAS curve shows a negative relationship between the price level and the real output in the economy. Macroeconomists have different explanations of the positive inclination of the

SRAS curve. The most widespread and scientifically grounded of them is the hypothesis of flexible wages that distinguishes between nominal and real wages and indicates that only real wages are flexible in the market economy. When the actual price level is higher than the expected price level, nominal wages cannot change immediately because they are agreed between employers and employees. However, real wages will be lower than expected wages that will lead to a decrease in labor costs and stimulate firms to increase the real output.

To be sure, build the SRAS curve in the economy of the country A that is characterized by the following indicators (Table 4.2).

Table 4.2

**The data for the aggregate supply curve**

Price levels, %	3.0	2.5	2.0	1.5	1.5
Real GDP, bln euros	500	400	300	200	100

Real GDP of the country A is on the horizontal axis, price level (or GDP deflator) is on the vertical axis (Fig. 4.7).

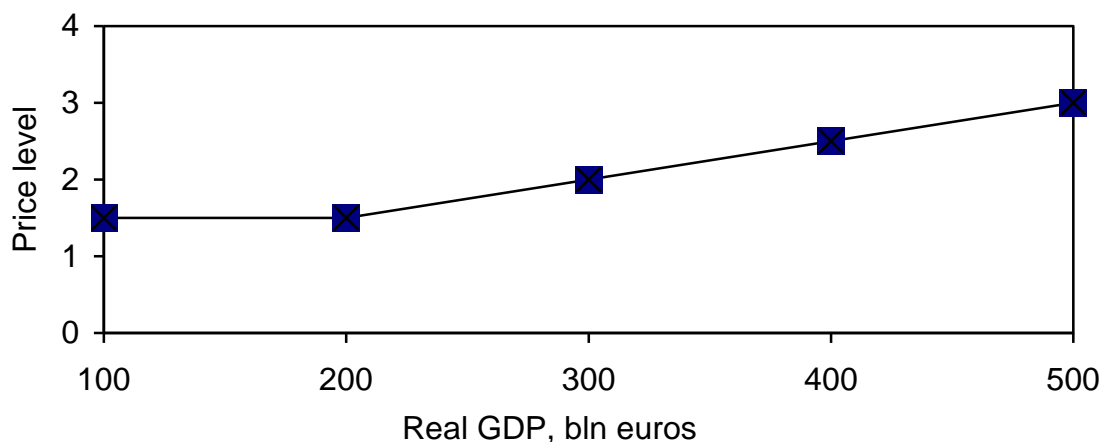

**Fig. 4.7. The aggregate supply curve of the country A in the short run**

There are also non-price-level determinants influencing aggregate supply and shifting the SRAS curve either leftward or rightward (Fig. 4.8). These are the following:

- 1) changes in input prices (or prices of factors of production):
  - a) changes in prices of domestic factors of production;
  - b) changes in prices of foreign factors of production;
- 2) changes in productivity of factors of production;
- 3) changes in fiscal policy.

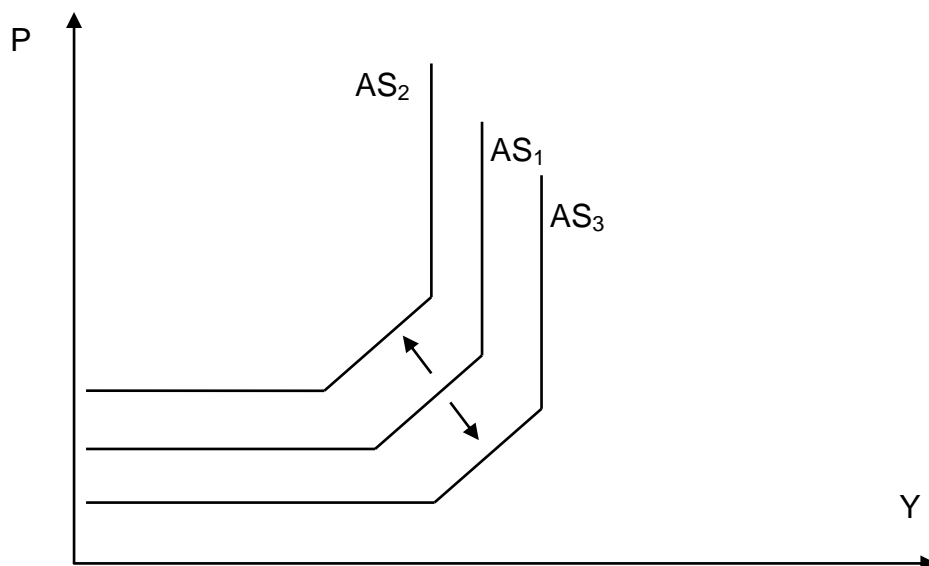

Fig. 4.8. **The influence of nonprice determinants on the SRAS curve**

It is time to consider how changes in input prices influence aggregate supply. When prices of domestic or foreign factors of production (capital, land, labor, entrepreneurial ability, knowledge, information, ecology and others) increase, the SRAS curve shifts leftward (from  $AS_1$  to  $AS_3$ ) because firms' costs increase and accordingly the total input drops. In contrast, when prices of domestic or foreign factors of production decline, the SRAS curve shifts rightward (from  $AS_1$  to  $AS_2$ ).

Changes in the productivity of factors of production is another key factor influencing aggregate supply. Analyzing this factor most economists mean only human productivity that, as we know, shows how much output can be produced with a given quantity of labor. Historically, human productivity constantly grows, so the same quantity of labor can produce more real GDP per capita. It is expedient to note that human productivity grows by 8 % per year in developed economies such as North American, South Korean, Japanese, German and French. Remember that an increase in human productivity leads to the increase in aggregate supply and results in shifting the SRAS curve to the right.

In some cases, the SRAS curve can shift either leftward or rightward due to a supply shock of the key factors of production or natural resources. It is known that an increase in prices of oil or other energy products on the world market leads to a reduction in GDP in extensive-growth economies and shifting the SRAS curve to the left there. As we know, American economy experienced a supply shock in the 1970s due to shocks on the world oil market.

### Interesting to know

#### **The experience of supply shock in the U.S. economy in the 1970s**

The most famous supply shock in the United States occurred in the oil markets in the 1970s when, as we remember from other disciplines (World History and Economic History), the economy experienced a period of strong stagflation. The Organization of Arab Petroleum Exporting Countries (OAPEC) placed an oil embargo on Western nations, including North American countries, in 1972. The nominal supply of crude oil did not considerably decrease but production processes were unaffected so the effective supply of oil in the North American market declined markedly and, as a result, prices rose.

In response to these changes, the U.S. government placed price controls on nonrenewable energy resources (oil, gas and coal) making production of them. To fight economic stagflation, the Federal Reserve Bank attempted to boost national economy using chief monetary instruments, but total output could not increase while government constraints remained in place.

Many economies are experiencing supply shocks today in consequence of an increase in the prices of oil and gas. In turn, shocks on the labor market have similar effects on the economy as a whole. When the economy is on the wave of immigration, the SRAS curve will most probably shift leftward and there will be fewer employees available to produce final goods and services. For instance, due to Russia's annexation of Crimea and the war conflict between Russia and Ukraine on the east of Ukraine about 7 mln people left the country during 2014 – 2018. As a result, nominal GDP of Ukraine increased by 1851.76 bln UAH (from 1588.24 bln UAH in 2014 to 3440 bln UAH in 2018).

Let's define the essence and nature of supply shocks more precisely. Supply shocks are surprise events that lead to decreased supply of output. The main cause of supply shocks is that an unexpected event causes a dramatic change in the future output. There are positive and negative supply shocks in a real economy. Positive supply shocks are usually caused by a technological advance or discovery of new natural resources. However, in some cases, positive supply shocks can have negative consequences for the total output. For example, a large increase in money supply, as a rule, only results in immediate, real benefits for households and firms who receive additional liquidity. But their benefit comes at the expense of all other members of the economy whose money loses purchasing power at the same

time. Over time, production becomes less efficient. Real wealth generators are left with fewer resources at their disposal than they otherwise would have had. Finally, both the AD curve and the SRAS curve shift leftward which leads to economic stagnation.

In contrast, the main causes of negative supply shocks are natural disasters such as hurricanes or earthquakes, changes in taxes or wages, wars. Any increase in input prices leads to the shifting of the SRAS curve leftward, raising the price level and reducing the real GDP.

Fiscal policy is also an important factor influencing the GDP of a country and shifting the SRAS curve. To stimulate domestic production, the government can use taxes and subsidies, major instruments of fiscal policy, but each of them has different effects. So there is negative relationship between taxes and aggregate supply in the country: if taxes rise, aggregate supply drops and the SRAS curve shifts to the left; if taxes are cut, aggregate supply goes up and the SRAS curve gradually shifts to the right. At the same time, subsidies got from the government allow the entrepreneurs to reduce their costs and, in that way, increase profits. Obviously, it results in shifting of the SRAS curve to the right.

As for aggregate supply in the long run, neoclassical economists (J. Hicks, G. Stigler) considerably contributed to the analysis of it. From their point of view, any economy usually acts in a state of full employment because flexible prices and wages help to eliminate standard deviations from natural unemployment. In other words, these economists did not distinguish between short and long run. At the same, most modern researches think that classical statements explain aggregate supply only in the long run because prices and wages can renew full employment only in the long run. To prove that, they propose to analyse the following situation.

Suppose aggregate demand increases with full employment that will result in an increase in the price level. Many firms will be interested in hiring more people to produce more goods and services. However, they will probably face one problem: there are no unemployed because labor market is in equilibrium. To solve this problem, employers will increase nominal wages; but increase in wages will be the same as increase in prices. This effect indicates that fixed real wages equilibrate labor market and eliminate cyclical unemployment. On the other hand, aggregate supply equals potential GDP because profitability in the industry does not change and firms are not motivated to increase or decrease their output. One can draw the following

conclusion. In the long run, an increase in prices will lead to an increase in nominal wages but other macroeconomic indicators, namely the natural unemployment rate and potential GDP, will be stable. Graphically it can be shown as a vertical line (Fig. 4.9).

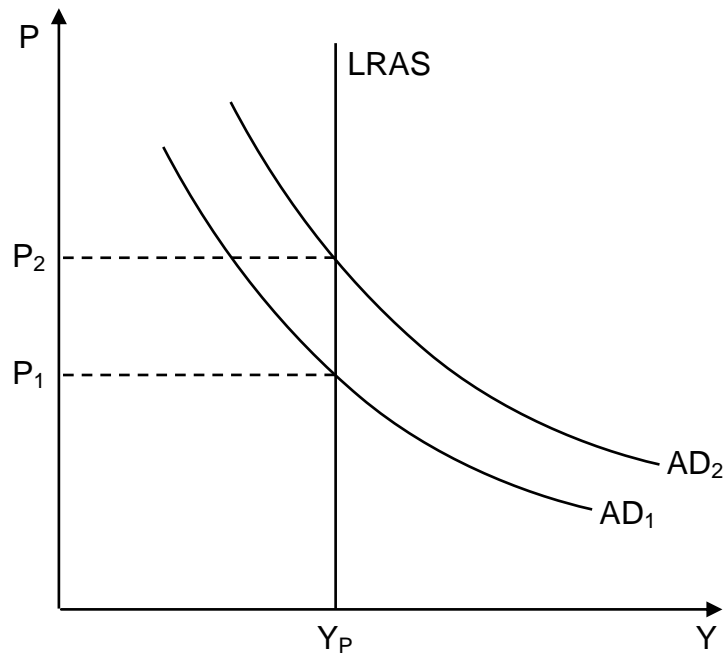

**Fig. 4.9. The aggregate supply curve in the long run**

Fig. 4.9 shows that the LRAS curve begins from potential GDP ( $Y_P$ ). It implies that any changes in aggregate demand do not influence aggregate supply; they change only the prices in the country. An increase in aggregate demand shifts the AD curve to the right (from  $AD_1$  to  $AD_2$ ) and increases the price level (from  $P_1$  to  $P_2$ ). But total output does not change and it equals potential GDP. To summarize, prices and wages are absolutely flexible in the long run, so prices do not influence aggregate supply and aggregate supply equals potential GDP. It means that non-price determinants influence aggregate supply in the long run. It can be expressed as the following production function:

$$Y_P = f(K, L), \tag{4.3}$$

$$\text{or } Y^{AS} = f(K, L), \tag{4.4}$$

where K is capital;  
L is labor.

### 4.3. The equilibrium between aggregate demand and aggregate supply

In sub-sections 4.1 – 4.2, the models of aggregate demand and aggregate supply were briefly described and, in that way, key tools for analysis of economic fluctuations in the short run were obtained. So one can also consider an AD – AS model and examine the mechanism of setting the equilibrium GDP and the equilibrium price level. Achieving a macroeconomic equilibrium means a certain state of the economy when aggregate expenditure equals aggregate income, or, in other words, aggregate demand equals aggregate supply. Admit, there is no macroeconomic equilibrium in each period of time. The market mechanism only provides a background both for breaking and re-establishment of a general equilibrium. In general, equilibrium is not a static phenomenon, in the economy, it is a dynamic process that acts as a tendency.

Interaction and the relationship between aggregate demand and aggregate supply are established through the price system. The point of crossing of the aggregate demand curve and the aggregate supply curve is the equilibrium point that determines the equilibrium price level and the equilibrium real GDP as well as the employment rate in the overall economy.

Let's first analyze the economy that is in the long run equilibrium (Fig. 4.10).

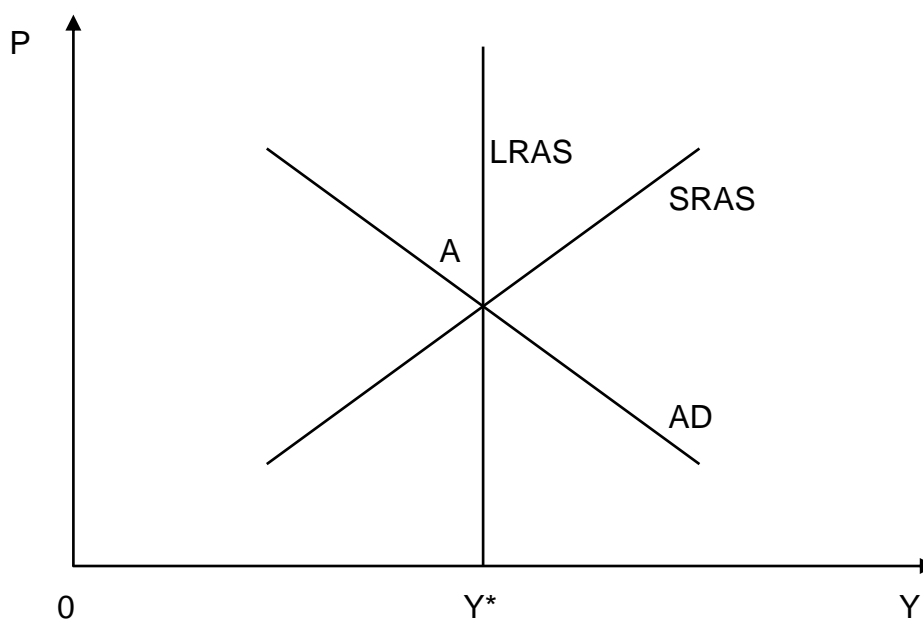
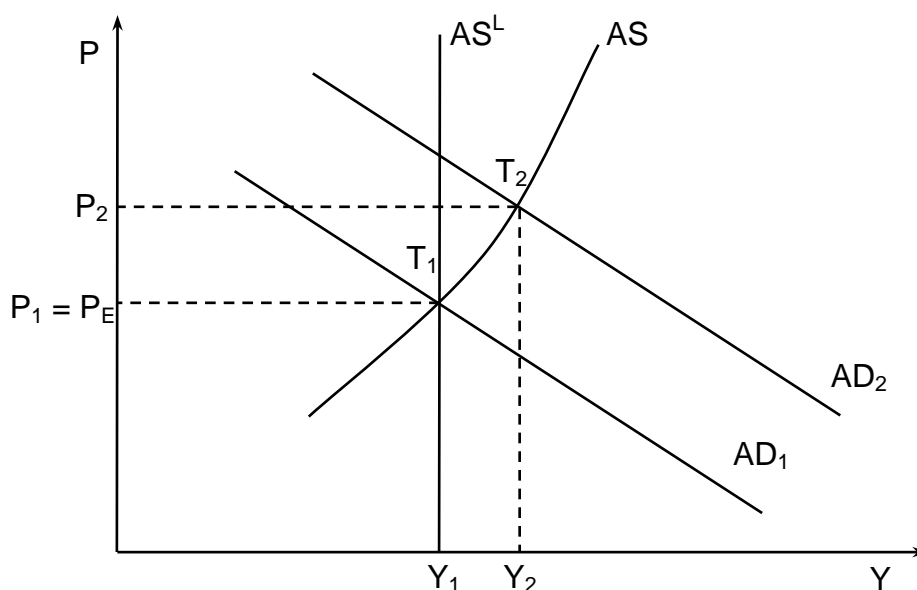

Fig. 4.10. A macroeconomic equilibrium in the long run



In Fig. 4.10 the equilibrium GDP and the equilibrium price level are determined by crossing the AD curve and the LRAS curve in the point A. This point demonstrates that actual GDP equals potential GDP in the long run. Besides, the SRAS curve also crosses the AD curve in the point A which means that the short-term aggregate supply coincides with the long-run aggregate supply, that is business expectations, wages and prices correspond to a long-run equilibrium.

Now let's determine the equilibrium between aggregate demand and aggregate supply in the short run (Fig. 4.11).



**Fig. 4.11. The general model of the equilibrium between aggregate demand and aggregate supply**

Fig. 4.11 shows that the original equilibrium in the economy is in the point  $T_1$  where  $AS$  crosses the  $AD_1$  curve. This economy is characterized by the following conditions: actual GDP equals potential GDP ( $Y = Y_P$ ), the actual price level equals the expected price level ( $P = P_E$ ), there is a lack of cyclical unemployment ( $u = u_N$ ). Shifting of the AD curve (from  $AD_1$  to  $AD_2$ ) leads to the increase in the price level (from  $P_1$  to  $P_2$ ), so the actual price level is becoming higher than the expected price level ( $P > P_E$ ). In consequence of these changes labor costs drop, which stimulates the entrepreneurs to increase the output (from  $Y_1$  to  $Y_2$ ). Thus, one can conclude: if the actual price level is higher than the expected price level ( $P > P_E$ ), actual GDP exceeds potential GDP ( $Y > Y_P$ ). Similarly, if the actual price level is lower than the expected price level ( $P < P_E$ ), actual GDP is lower than potential GDP ( $Y < Y_P$ ).

As mentioned above, the mechanism of setting an equilibrium GDP in the short run mainly depends on in what zone of the SRAS curve the AD curve crosses it. When AD crosses the SRAS curve in the horizontal zone (Fig. 4.12), real GDP increases but prices are becoming sticky.

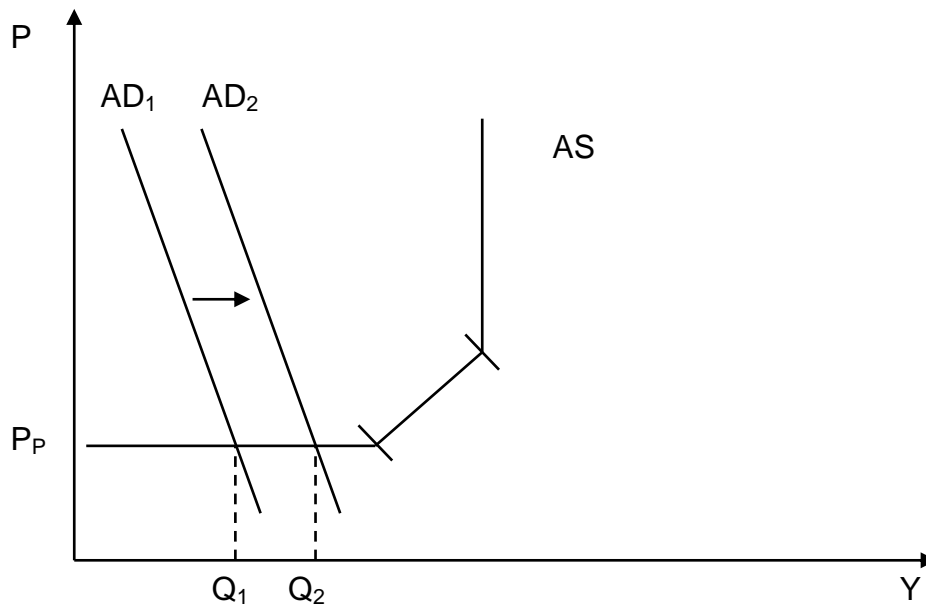

Fig. 4.12. **Shifting of the AD curve in the horizontal zone of the SRAS curve**

When AD crosses the SRAS curve in the vertical zone (Fig. 4.13), prices increase but real GDP is constant under the conditions of full employment.

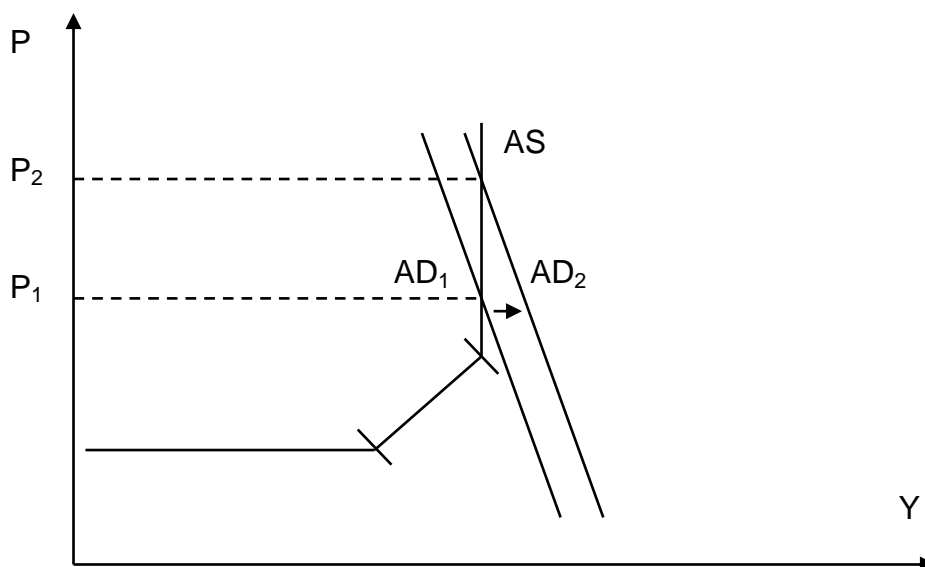
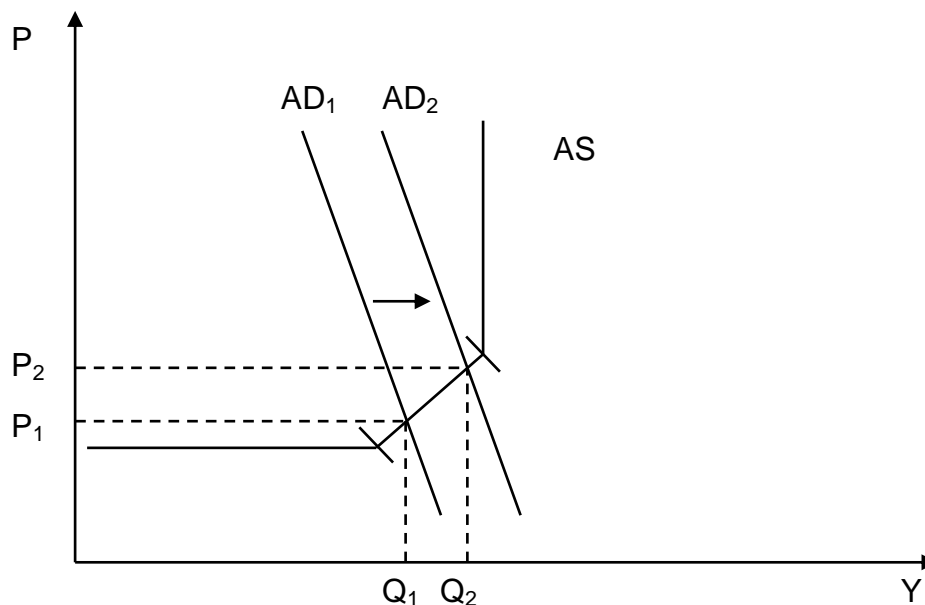

Fig. 4.13. **Shifting of the AD curve in the vertical zone of the SRAS curve**

When AD crosses the SRAS curve in the intermediate zone (Fig. 4.14), both real GDP and price level increase. Besides, the increase in aggregate demand in the vertical and intermediate zones of the SRAS curve points out a demand-pull inflation that is discussed in sector 6.



**Fig. 4.14. Shifting of the AD curve in the intermediate zone of the SRAS curve**

Therefore, one can conclude: aggregate supply mostly depends on aggregate demand in the short run and an increase in aggregate demand can stimulate an increase in aggregate supply for a long time until it reaches a full employment level of GDP. It is the basic statement of Keynesian theory. In Keynes' view, under the conditions of cyclical unemployment and sticky prices, volatility of aggregate demand causes, first of all, changes in real GDP and only after that changes in price level might be observed. From this, the Keynesians (A. Hansen, R. Harrod, J. Hicks, L. Klein, E. Lundberg, R. Metzner, P. Samuelson, J. Tinbergen) argued the following: if the government aims to increase real GDP, then it should stimulate aggregate demand using the instruments of fiscal policy, in particular an increase in government purchases of goods and services, tax cuts and an increase in transfers.

Decrease in aggregate demand relates to another problem. When aggregate demand decreases in the Keynesian zone of the SRAS curve, the AD curve shifts leftward which leads to the decrease in the equilibrium

GDP and increase in unemployment with sticky prices. At the same time, a decrease in aggregate demand in the intermediate and classical zones of the SRAS curve is more complex to explain. The problem is that prices of both the resources and the output are inflexible, consequently they do not tend to decrease. So, this causes a so-called ratchet effect (a ratchet is a mechanism that allows you to turn the wheel forward, but not back). Prices do not decrease as easily as they rise, especially in the short run (Fig. 4.15).

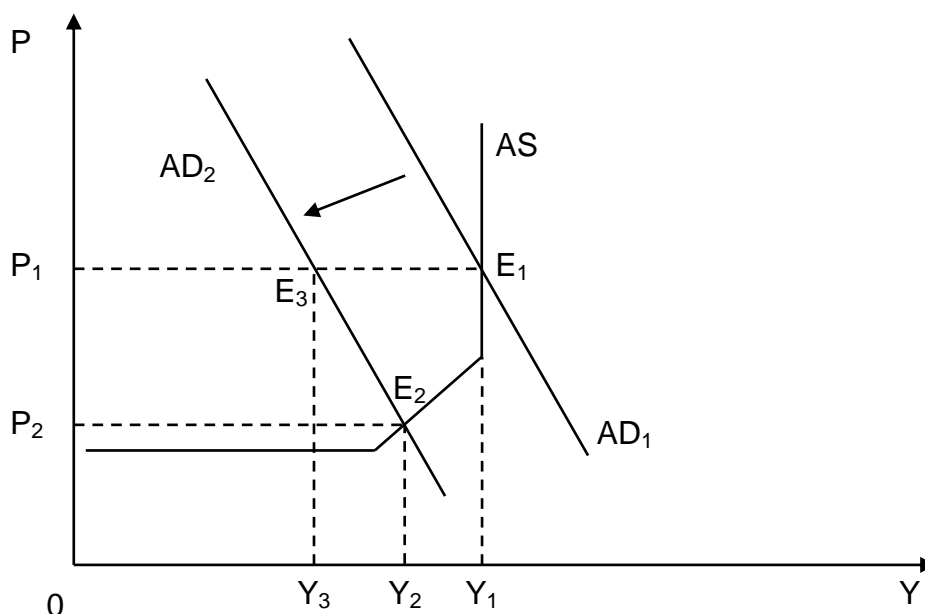
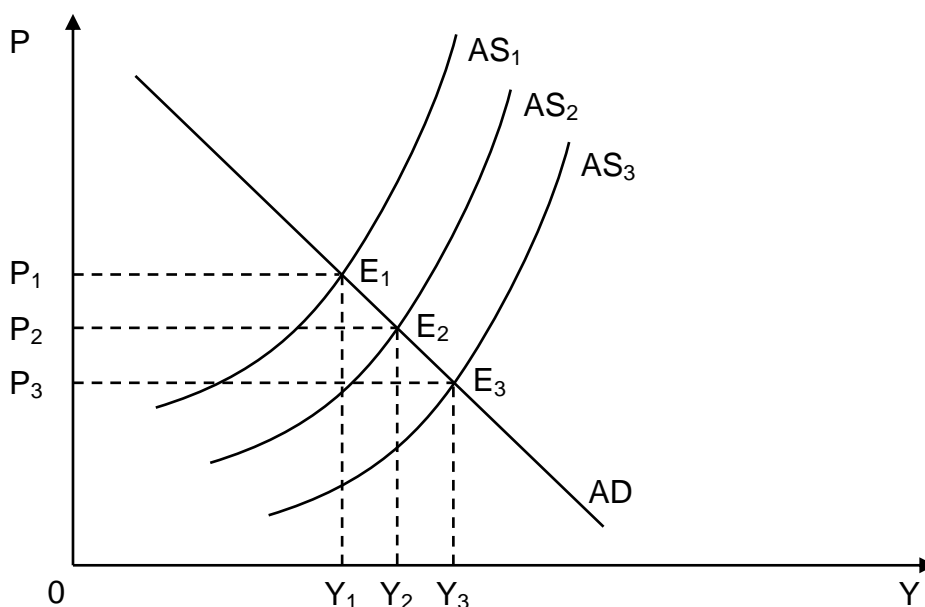

Fig. 4.15. The ratchet model

As Fig. 4.15 shows, when aggregate demand decreases (from  $AD_1$  to  $AD_2$ ), the macroeconomic equilibrium does not establish at point  $E_2$ . According to the ratchet effect, the price level will remain invariably high, and the narrowing aggregate demand will shift the equilibrium to point  $E_3$  which, in turn, will lead to a decrease in GDP (from  $Y_1$  to  $Y_3$ ). In effect, the SRAS curve will change a bit – its Keynesian zone will shift from  $P_1$  to  $P_2$ . In other words, asymmetry is observed on the SRAS curve that can be explained as follows. When aggregate demand increases, the Keynesian zone of the SRAS curve deviates up easily and quickly, but when aggregate demand decreases, the SRAS curve deviates down slowly or even does not deviate. In Ukrainian economy, the ratchet effect often acts when prices of consumer goods and services increase. For instance, hryvnia, the national currency of Ukraine, sharply dropped in 2014 – 2015 which led to an

increase in prices of foreign goods and services. The exchange rate stabilized in 2016 and we could have expected a decrease in prices of domestic and foreign goods but it did not happen because of the ratchet effect.

Now let's consider how changes in aggregate supply influence the macroeconomic equilibrium in the short run (Fig. 4.16). Shifting of the SRAS curve rightward (from  $AS_1$  to  $AS_2$ ) implies an increase in real GDP (from  $Y_1$  to  $Y_2$ ), a drop in the unemployment rate and a decrease in the price level (from  $P_1$  to  $P_2$ ). On the other hand, shifting of the SRAS curve leftward (from  $AS_1$  to  $AS_3$ ) illustrates an increase in production costs per unit, an increase in the price level (from  $P_1$  to  $P_3$ ), a decrease in the equilibrium real GDP (from  $Y_1$  to  $Y_3$ ) and an increase in the unemployment rate.



**Fig. 4.16. Changes in the macroeconomic equilibrium in the short run influencing the changes in aggregate supply**

How does the macroeconomic equilibrium in the short run turn into the macroeconomic equilibrium in the long run? When aggregate demand increases after immediate reaction and the establishment of the short-run macroeconomic equilibrium, the movement toward the stable long-run equilibrium continues. This transition is carried out by means of adjustment of prices (Fig. 4.17).

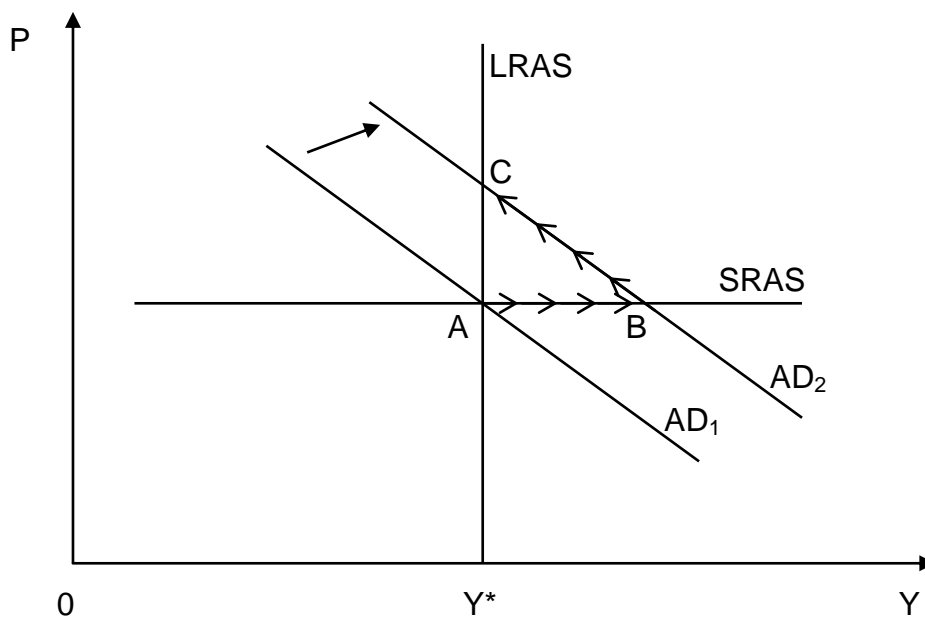
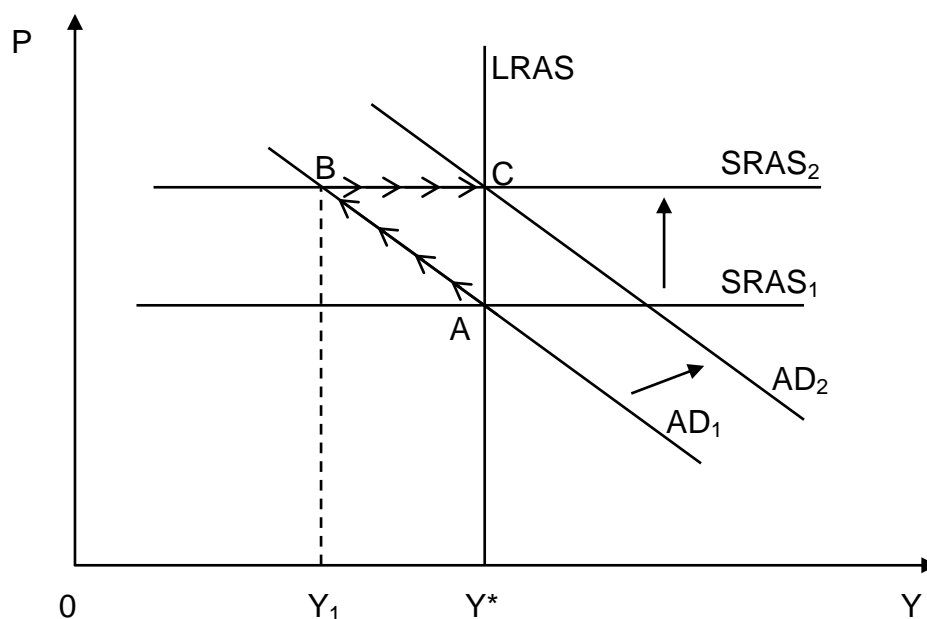

**Fig. 4.17. Changes in the macroeconomic equilibrium in the long run influencing the changes in aggregate demand**

Suppose, for example, that expansionary monetary policy results in an increase in aggregate demand (from  $AD_1$  to  $AD_2$ ). In the short run, the economy shifts the SRAS curve to the right (from point A to point B) where the actual GDP exceeds the potential GDP ( $Y > Y^*$ ) but prices are sticky. Total output increases because aggregate demand increases, but during some time goods and services are sold at old prices. In our analysis, production costs are significantly increasing because a lack of production factors results in an increase in prices for them. It leads to higher prices of final goods and services (from point B to point C on the AD curve) and, as a result, the magnitude of aggregate demand begins to decrease and the economy returns to the previous level of release, but even at a higher price level. A long-run macroeconomic equilibrium sets at point C.

Thereby, regardless of the reasons that caused changes in aggregate demand and its shifting from the initial equilibrium, the economy, by self-regulation, returns to the level of the potential GDP characterized by the existing production factors and technology in the long run.

The same self-regulation occurs when aggregate supply varies in the short run. For example, an increase in the price of gas leads to the increase in the price level in the overall economy. It is shown in Fig. 4.18 as a shifting of the SRAS curve rightward (from the  $SRAS_1$  curve to the  $SRAS_2$  curve) and dropping in the real GDP (from  $Y_1$  to  $Y_2$ ).



**Fig. 4.18. Changes in the macroeconomic equilibrium in the long run influencing the changes in aggregate supply**

If the government does not intervene in the economy, the price level markedly decreases and the real output lags behind the potential one ( $Y_1 < Y^*$ ) under cyclical employment until unemployment rate and output return to the previous point. It corresponds to the changes in business expectations, wages and prices for final goods and services. Graphically it is shown as movement along the  $AD_1$  curve (from point B to point A). However, the process of adaptation of the economy may turn out to be too long and socially dangerous. To fight the decline in the real GDP, the government can increase money supply or total expenditure that will cause shifting of the AD curve rightward (from  $AD_1$  to  $AD_2$ ). In this situation, the price level at the output remains at the pre-crisis level but prices at the input will rise. It is shown at the equilibrium point C in Fig. 4.18.

After all, aggregate demand is not the most important factor influencing the dynamics of real GDP. For that reason, in the classical economists' view, aggregate supply and factors influencing it play a great role in boosting the economy. If the AS curve is vertical, the real GDP is determined only by the size of the potential GDP. Aggregate demand changes the price level, but not the size of the real GDP. Indeed, the long-run effect of shifting of the AD curve means changes in the nominal variables but not in the real values, so the size of the real output is fixed.

At the present time there are some other newest theories according to which changes in the total output and unemployment rate are also possible in the long run, so the economic downturn can cause undesirable long-run effects and lead to a change in the natural unemployment rate. One of the mechanisms of such unfavorable influence is so-called hysteresis that means a long-term effect caused by fluctuations in demand and supply on the natural value of economic parameters. For example, an economic downturn may lead to the following problem. People who are unemployed for a long time, lose qualification and even during the economic boom, they cannot find a job which results in an increase in the natural unemployment rate.

To summarize the explanations, despite the fact that the AD – AS model is a simplified version of a deeper reality, it allows us to estimate the influence of demand and supply shocks (or abrupt changes) on the whole economy as well as to forecast the consequences of stabilization policy aiming to fight fluctuations caused by shocks, and the establishment of an equilibrium GDP.

## Glossary

**Aggregate demand** is the size of total spending of key macroeconomic agents (households, enterprises, the government and the rest of the world) on domestic goods and services at each price level.

**Wealth effect (or real-balance effect)** means that change in the price level in a country leads to change in the real value of the wealth of a nation.

**Interest rate effect** means that when the price level in the country goes up, the purchasing power of the national currency decreases and accordingly the interest rate falls.

**Foreign price effect** means that when the price level in the country goes up, consumer demand for foreign goods and services in that country increases because they become cheaper compared with domestic products.

**Demand shocks** are surprise events that lead to an increased or decreased demand for the output.

**Aggregate supply (AS)** is the output produced and sold in a given period.

**Supply shocks** are surprise events that lead to a decreased supply of the output.



## Questions for self-assessment

1. What is aggregate demand? What nonprice determinants influence the aggregate demand?
2. How can demographics affect aggregate demand?
3. What can aggregate demand shift to the right?
4. What is aggregate supply? Why does it slope up?
5. What zones does aggregate supply consist of? What are the key features of each one?
6. Distinguish between the short-run aggregate supply (SRAS) and the long-run aggregate supply (LRAS).
7. What did J.-B. Say think about the conditions of a general equilibrium? What did J. Keynes think about the conditions of a general equilibrium?
8. Interpret the AD – AS model. What does the equilibrium point show?
9. How does unemployment influence the AD – AS model in the short run?
10. What are the sources of inflationary pressure in the AD – AS model?

## Review questions

1. Assume that country Z is in the condition of a potential GDP. Explain how each of the following will affect the general equilibrium in this country:
  - a) technological advance;
  - b) increase in the prices of gas;
  - c) productivity slowdown;
  - d) raising the interest rate;
  - e) raising the mortgage rates;
  - f) a decline in farm products because of droughts.
2. Give examples of at least three economies that experienced a general equilibrium in the long run during the 20th – 21st centuries.
3. What are the key characteristics of an overheated economy? Prove that Chinese economy was overheated in 2015 – 2017 gathering the necessary statistics and presenting them graphically.
4. Gross private investment and consumption expenditure significantly plummeted in Ukraine in 2014 – 2015. Use the AD – AS model to explain how it influenced the real GDP and price levels.

5. How could the interest rate effect of the increase in the supply of financial assets cause AD to fall?

6. Explain the role of extraordinary hazards such as floods, droughts or insects in causing and ending adverse supply shocks. Give examples of at least two economies that experienced this type of shocks in the 21st century.

7. Explain the role of the decrease in prices of oil in causing and ending favorable supply shocks. Give examples of at least two economies that experienced this type of shocks in the 21st century.

8. Suppose the economy of the country Beta is in the long-run equilibrium. Changes in the banking system led to the increase in the money velocity. The Central Bank of Beta increased money supply. Show graphically the initial situation, the shock situation and stabilization policy of the Central Bank of Beta.

9. Explain the evolution of residual shocks. Are there any positive effects of residual shocks on GDP?

10. Do you think it is easier for the National Bank of Ukraine to fight the consequences of aggregate demand shocks or aggregate supply shocks?

### Tests

1. Aggregate demand does not include the following component:

- a) consumption expenditure;
- b) net investment;
- c) government purchases of goods and services;
- d) net export.

2. The aggregate demand curve shows the relationship between the following indicators:

- a) real GDP and price level;
- b) real GDP and unemployment rate;
- c) nominal GDP and price level;
- d) nominal GDP and inflation rate.

3. Downward sloping of the aggregate demand curve is caused by the following:

- a) wealth effect;
- b) interest rate effect;
- c) foreign price effect;
- d) all the above mentioned.

4. If households' income rises, then:
- a) aggregate demand decreases;
  - b) aggregate demand increases;
  - c) aggregate supply decreases;
  - d) aggregate supply increases.
5. The increase in the price level on the aggregate demand curve is an example of this type of inflation:
- a) crowded inflation;
  - b) hyperinflation;
  - c) demand-pull inflation;
  - d) cost-push inflation.
6. The aggregate demand curve shifts when:
- a) prices of dominant energy resources change;
  - b) labor productivity increases;
  - c) taxes on production are cut;
  - d) households' expectations for future incomes change.
7. Which of the following economists stated that aggregate demand creates its own aggregate supply:
- a) A. Okun;
  - b) J. Keynes;
  - c) A. Phillips;
  - d) J.-B. Say?
8. Which of the following zones of the SRAS curve slopes upward:
- a) the Keynesian zone;
  - b) the intermediate zone;
  - c) the neoclassical zone;
  - d) the answer is not given.
9. The feature(s) of the neoclassical zone of the SRAS curve is(are):
- a) natural unemployment is high, cyclical unemployment is low;
  - b) natural unemployment is low, cyclical unemployment is high;
  - c) cyclical unemployment is high, structural unemployment is low;
  - d) cyclical unemployment is low, structural unemployment is high.
10. The long-run aggregate supply curve is:
- a) a vertical line;
  - b) a horizontal line;
  - c) a hyperbola;
  - d) a parabola.

Answers: 1b; 2c; 3d; 4a; 5c; 6d; 7b; 8b; 9a; 10b.

## 5. Money market

The section is devoted to studying the role that money plays in the economy. Changes in the amount of money can have a significant impact on various macroeconomic indicators, such as inflation, income, output, interest rate. This section discusses the functions of money, monetary aggregates, with the help of which the amount of money in the economy is measured. The analysis of the demand for money, money supply and equilibrium in the money market is provided. The factors on which the demand for money depends are examined, and it is shown how the central bank and commercial banks can influence the money supply in the economy. The analysis is based on simple economic concepts that help to understand the importance of interest rates and money for the economy.

The purpose of studying the topic is the formation of such students' competences as: knowledge of the mechanism of monetary policy and the banking system of the state, as well as skills in the use of the tools and methods of monetary policy.

5.1. The mechanism of the money market.

5.2. The banking system and the money supply.

**Key terms:** money, money supply, monetary base, money market, money aggregate, demand for money, equilibrium in the money market, bank, banking system, money multiplier, bank multiplier, deposits, monetary policy.

### 5.1. The mechanism of the money market

The quantity of money (e.g. M1) is determined by the Federal Reserve (the Fed) through its control of the reserve requirement and money creation by the banking system. The price of money is the interest rate. The interest rate is the price of money because it is what borrowers must pay to obtain money and it is also the opportunity cost of holding money rather than loaning it out.

The money market consists of the demand for money (MD) and the supply of money (MS). The Fed determines the quantity of money supplied.

Since it is determined by the Fed, the *money supply* is independent of the interest rate, and the money supply curve is a vertical line.

The *demand for money* is based on a decision by consumers to hold wealth in the form of interest-bearing assets (e.g. savings accounts) or as money (noninterest-bearing).

There are three types of money demand, based on the three basic motives people have for holding money (rather than interest-bearing assets):

*transactions demand* – to make purchases of goods and services;

*precautionary demand* – to serve as protection against an unexpected need;

*speculative demand* – to serve as a store of wealth.

The demand for money is a function of interest rates and income. The interest rate is the opportunity cost of holding money because it represents the forgone interest income that was given up in order to hold money.

The demand for money has an inverse relationship with the interest rate. As the interest rate increases, the opportunity cost of holding money increases and people hold less money. As the interest rate falls, the opportunity cost of holding money falls and people hold more money.

The negatively sloped demand curve for money represents the quantity of money demanded at various interest rates.

1. Now, suppose there is an increase in the money supply. Show the change in the money supply and the resulting change in the equilibrium interest rate in Fig. 5.1.

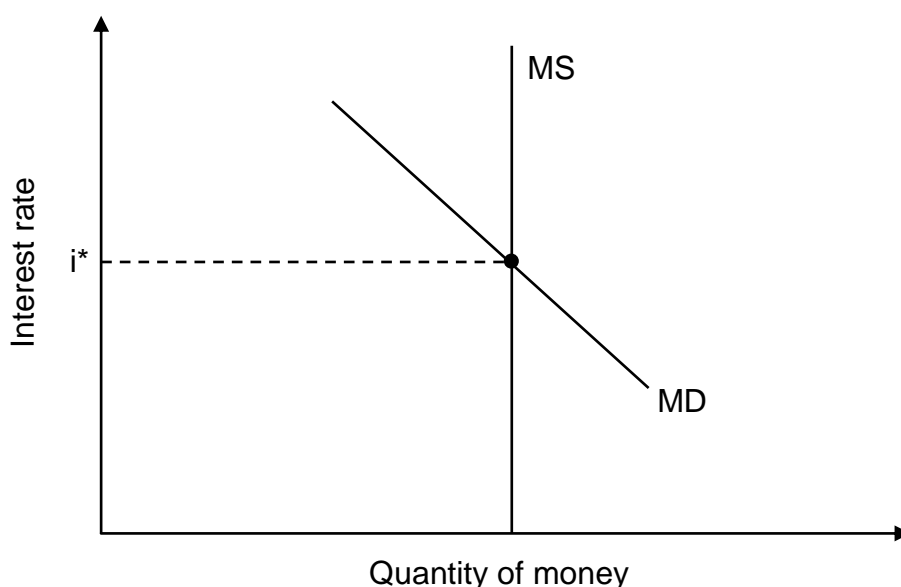

Fig. 5.1. **The money market**

What happens to the quantity of money demanded when the interest rate changes?

What happens to the quantity of loans as the interest rate changes? Explain.

The quantity of money demanded increases as the interest rate falls. The quantity of loans increases. This is because the interest rate is the price of loans and the opportunity cost of holding money.

2. Now draw a new graph of the money market, illustrating the equilibrium interest rate (Fig. 5.2).

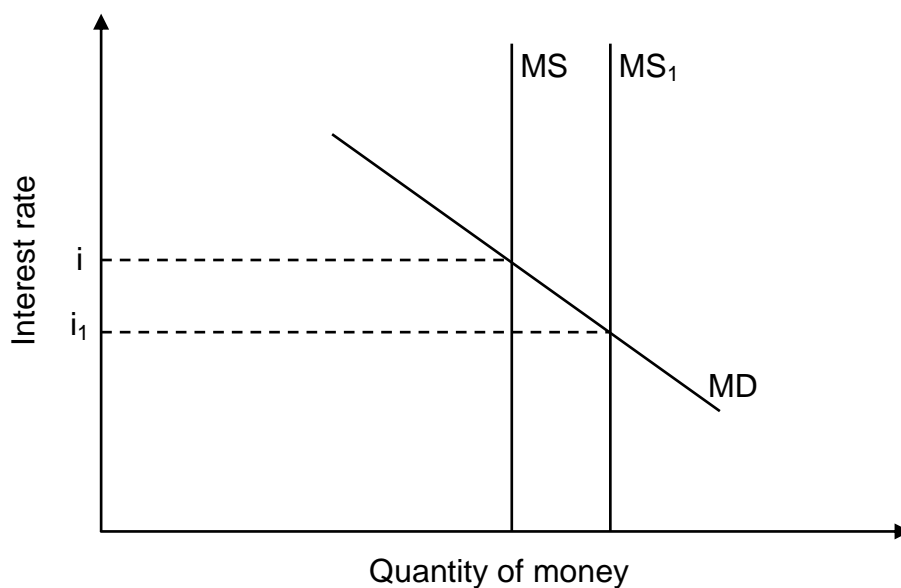

Fig. 5.2. The equilibrium interest rate

3. Suppose the demand for money increases.

Show the change in money demand and the resulting interest rate in Fig. 5.3.

What happens to the quantity of loans as the interest rate changes? Explain.

Money is an important factor which is used as a medium of exchange for undertaking transactions and for holding as an asset. Money can perform these functions if it is kept scarce, that is, supply of money at a given point of time is fixed and over time it is increased at a limited rate.

Therefore, the Central Bank of a country (in case of India, the Reserve Bank of India) is given the right to control the supply of money in the economy. The money supply is fixed by the policy actions of the Central Bank of a country. Through open market operations, changes in the cost reserve ratio (CRR) of banks, the Central Bank of a country can influence the creation of bank credit which constitutes an important part of the money supply of the country.

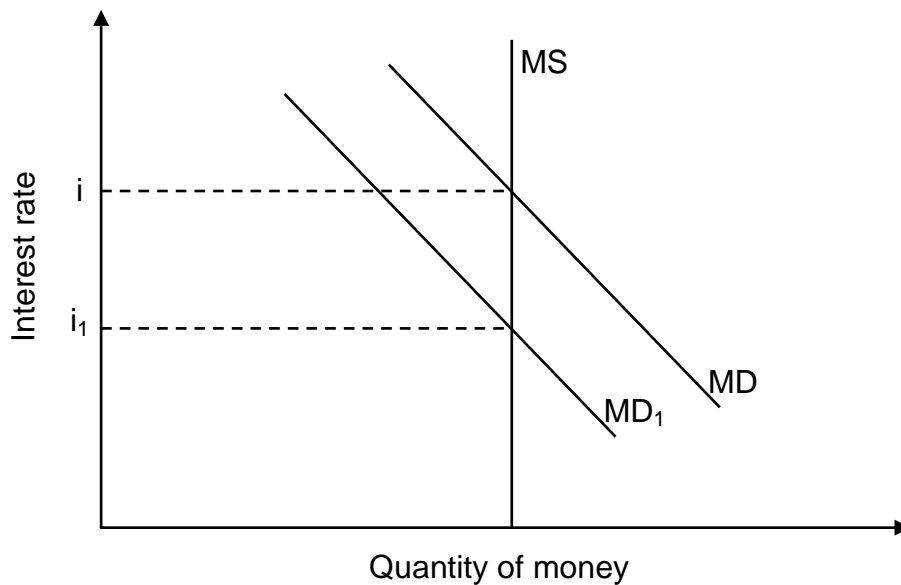

**Fig. 5.3. The change in money demand and the resulting interest rate**

Besides, the extent to which the Central Bank of the country absorbs foreign exchange reserves, also affects the supply of money in the economy. When the Reserve Bank of India buys more foreign exchange from the market, it issues new money to make payments for purchase of foreign exchange from the market.

However, it is assumed that money supply does not vary with either the level of income or the rate of interest unless the Reserve Bank decides to change it. In Fig. 5.4 we have therefore drawn a vertical supply curve of money with measuring the interest rate on the Y-axis.

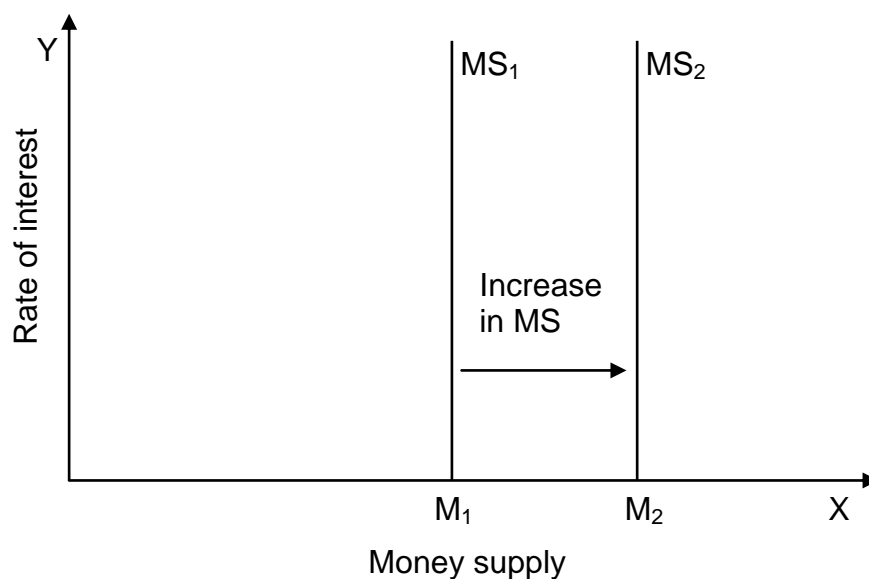

**Fig. 5.4. Money supply is independent of the rate of interest**

If the Central Bank of the country decides to increase money supply and fixes it at  $M_2$ , the money supply curve will shift to the right as shown in Fig. 5.4. On the other hand, if the Central Bank decides to reduce money supply in the economy, the money supply curve will shift to the left.

*The money supply curve is vertical.* Money supply is ultimately determined by the monetary base and the money multiplier. In most countries, the country's central bank determines the size of the monetary base. Remember that the monetary base includes reserves in vaults and currency in circulation outside of banks. For example, central banks might change the reserve requirements to change the monetary base.

Money supply doesn't depend on the interest rate, it only depends on the central bank. Because of this, the money supply curve is vertical at the quantity of the money supply, not upward sloping or downward sloping.

*The nominal interest rate adjusts until the money market is in equilibrium.*

In any market, an equilibrium occurs when the quantity supplied is equal to the quantity demanded. Prices adjust until the market is in equilibrium. The money market is no exception. The only difference between the markets described in section 3 and 4 and the money market is:

- price is the nominal interest rate;
- the supply curve is vertical.

In the money market, the nominal interest rate adjusts until the quantity of money that people want to hold is the same as the quantity of money that exists. If the nominal interest rate is above the equilibrium high, people reduce their holdings of cash. If the nominal interest rate is below the equilibrium, they increase their holdings of cash.

#### **Interesting to know**

What makes people want to hold exactly the amount of cash that exists? Let's go back to our example where we have \$1000 in the form of bonds. When the interest rate is very low, such as 2 %, the return to those bonds is low. The opportunity cost of keeping wealth in cash (which we can also use to buy stuff) is very low.

Also, recall that interest rates and bond prices are inversely related, so a low-interest rate means we can get a high price for these bonds. This sounds like a no-brainer. Let's sell off those and get some cash!

Unfortunately, everyone else has the same idea. Suppose at an interest rate of 2 %, people want to hold \$500 million in cash. But, the money supply is only \$300 million.

(to be continued)



(continued from p. 88)

There is a shortage of the thing we want (cash), so we have to try even harder to get that cash by selling even more bonds.

As the supply of bonds increases, the price of bonds decreases. Since bond prices and interest rates are inversely related, the interest rate starts creeping up. The interest rate will keep increasing until people decide that the return to holding bonds is high enough to stop selling them off. Now, the money market is in equilibrium and the quantity of money supplied equals the quantity of money demanded.

Something similar happens when the interest rate is very high. Suppose at an interest rate of 20 %, bonds are very attractive but cash isn't. People start trying to trade in their cash for bonds. The demand for bonds increases, which increases the price of bonds. As bond prices increase, the interest rate decreases. Interest rates decrease until bonds don't really seem that attractive anymore, and people stop trying to trade in cash for bonds.

The central bank controls the money supply, so it can take actions to increase or decrease the money supply. Changes in the money supply lead to changes in the interest rate.

But what about the demand for money, can it change? Absolutely! There are a few reasons why the demand for money might change:

*changes in national income* – when real GDP increases, there are more goods and services to be bought. More money will be needed to purchase them. On the other hand, a decrease in real GDP will cause the money demand curve to decrease;

*changes in the price level (inflation or deflation)* – if the price of everything increases by 20 %, you need 20 % more money in order to buy things. When there is an increase in the price level, the demand for money increases. Conversely, when there is a decrease in the price level, the demand for money decreases;

*changes in the money technology* – the demand for money is driven by the transactions motive (we want money so we can buy things). When new technologies make it easier to convert wealth into money, we keep less of it on hand.

## **5.2. The banking system and the money supply**

Once the Central Bank of a country fixes the money supply in the economy, households and business firms can make individual decisions

regarding how much money to hold. But the total money supply will be unaffected by their decisions to hold more or less money to fulfill transaction and speculative purposes. Money market is in equilibrium at a rate of interest when demand for money is equal to the fixed money supply. Thus, money market is in equilibrium when

$$MS = MD. \quad (5.1)$$

Money demand (MD) is determined by the level of income and the rate of interest. Assuming that money demand is a linear function, we can write it as

$$MD = k \times Y - h \times i. \quad (5.2)$$

Thus, money market is in equilibrium when

$$MS = k \times Y - h \times i \quad (5.3)$$

or

$$i = 1/h (k \times Y - MS) \dots \quad (5.4)$$

Thus, equation (5.4) describes the money market equilibrium. Given the level of income (Y), we can determine the rate of interest (i). The rate of interest, according to J. M. Keynes, is determined by demand for money (liquidity preference) and supply of money. The supply of money, at a given time, is fixed by the monetary authority of the country. In Fig. 5.5, MD is the demand curve for money at a given level of the nominal income.

MS is the money supply curve which is a vertical straight line showing that 200 crores of rupees is the money supply fixed by the monetary authority. It will be seen that the quantity demanded of money equals the given money supply at the 10 per cent rate of interest. So the money market is in equilibrium at the 10 per cent rate of interest. There will be disequilibrium if the rate of interest is either higher or lower than 10 per cent.

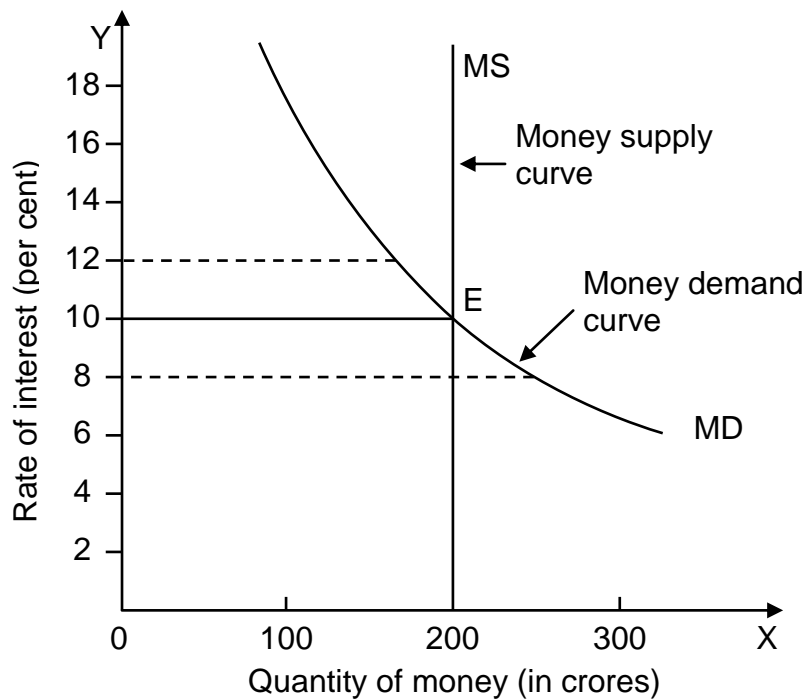

Fig. 5.5. **Money market equilibrium**

Suppose the rate of interest is 12 per cent. It is seen from Fig. 5.5 that at the 12 per cent rate of interest, the given supply of money exceeds the demand for money. The excess supply of money reflects the fact that people do not want to hold as much money in their portfolio as the monetary authority has made it available to them.

The people holding assets in the present two-asset economy would react to this excess money supply with them by buying bonds and thus replace some money in their portfolios with bonds. Since the total money supply at a given moment remains fixed, it cannot be reduced by buying bonds by individuals. But the bond-buying spree would lead to the rise in prices of bonds. The rise in bond prices means a fall in the rate of interest.

As can be seen from Fig. 5.5, with the fall in the interest rate from 12 per cent to 10 per cent, the quantity demanded for money has increased to be once again equal to the given supply of money and the excess supply of money is entirely eliminated and the money market equilibrium is restored.

On the other hand, if the rate of interest is lower than the equilibrium rate of 10 per cent, say it is 8 per cent, then, as can be seen from Fig. 5.5, there will emerge an excess demand for money. As a reaction to this excess demand for money, people would like to sell bonds in order to obtain a greater quantity of money for holding at the lower rate of interest.

The stock of money remaining fixed, the attempt by the people to hold more money balances at a rate of interest lower than the equilibrium level

through sale of bonds will only cause the bond prices to fall. The fall in bond prices implies the rise in the rate of interest.

Thus, the process started as a reaction to the excess demand for money at an interest rate below the equilibrium level will end up with the rise in the interest rate to the equilibrium level.

Let us now examine the effect of the increase in money supply on the rate of interest. Fig. 5.6, MD is the demand for money for satisfying various motives. To begin with,  $OM_1$  is the quantity of money available. The rate of interest will be determined where the demand for money is in balance or equal to the fixed supply of money  $OM_1$ . It is clear from Fig. 5.6 that the demand for money is equal to the  $OM_1$  quantity of money at the  $i$  rate of interest.

Hence  $i$  is the equilibrium rate of interest. Assuming no change in the expectations and the nominal income, an increase in the quantity of money (through buying securities by the Central Bank of the country from the open market) will lower the rate of interest.

In Fig. 5.6, when the quantity of money increases from  $OM_1$  to  $OM_2$ , the rate of interest falls from  $i$  to  $i'$  because the new quantity of money  $OM_2$  is in balance with the demand for money at the  $i'$  rate of interest. In this case we move down on the curve. Thus, given the money demand curve or the curve of the liquidity preference, an increase in the supply of money brings down the rate of interest.

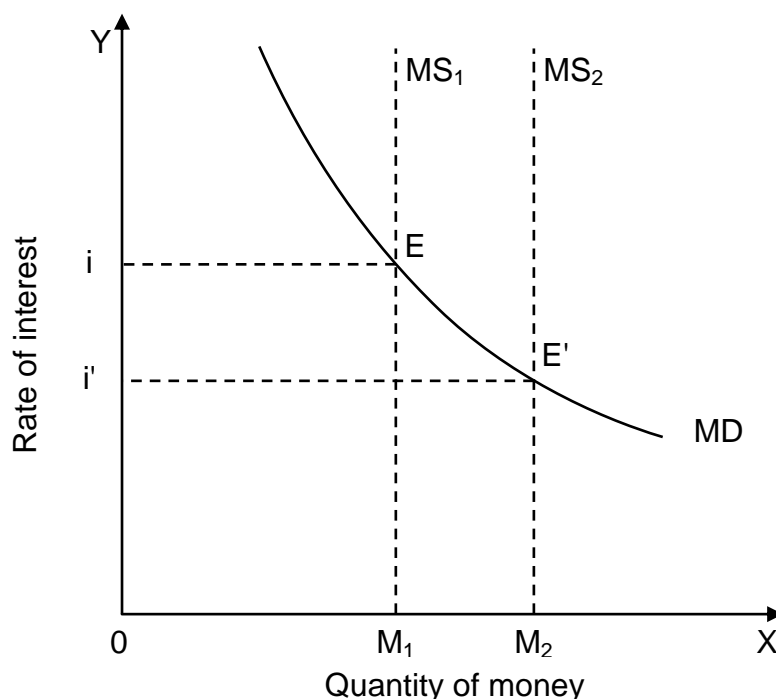

Fig. 5.6. The effect of the increase in money supply on the rate of interest

Let us see how an increase in the money supply leads to a fall in the rate of interest. With initial equilibrium at  $i$ , when the money supply is expanded from  $M_1$  to  $M_2$ , there emerges an excess supply of money at the initial  $i$  rate of interest. The people would react to this excess quantity of money supplied by buying bonds.

As a result, the bond prices will go up which implies that the rate of interest will decline. This is how the increase in the money supply leads to the fall in the rate of interest.

The effect of the increase in the money demand: the position of the money demand curve depends upon two factors:

- 1) the level of nominal income;
- 2) the expectations about the changes in bond prices in the future which implies changes in the rate of interest in future.

A money demand curve is drawn by assuming a certain level of nominal income. With the increase in nominal income, money demand for transactions motive increases causing an upward shift in the money demand curve. A shift in the money demand curve (or what Keynes called the liquidity preference curve) can also be caused by changes in the expectations of the people regarding the changes in bond prices or movements in the rate of interest in the future.

If some changes in the events lead the people on balance to expect a higher rate of interest in the future than they had previously supposed, the money demand or liquidity preference for speculative motive will increase which will bring about an upward shift in the money demand curve or liquidity preference curve and this will raise the rate of interest.

In Fig. 5.7, assuming that the quantity of money remains unchanged at  $M$ , the shift in the money demand curve from  $MD_1$  to  $MD_2$ , the rate of interest rises from  $i_1$  to  $i_2$  because at  $i_2$ , the new demand for money is in equilibrium with the supply of money  $OM$ .

It is worth noting that when the money demand curve shifts from  $MD_1$  to  $MD_2$ , the amount of money held does not increase; it remains  $OM$  as before. Only the rate of interest rises from  $i_1$  to  $i_2$  to equilibrate the new liquidity preference or money demand with the available quantity of money  $OM$ .

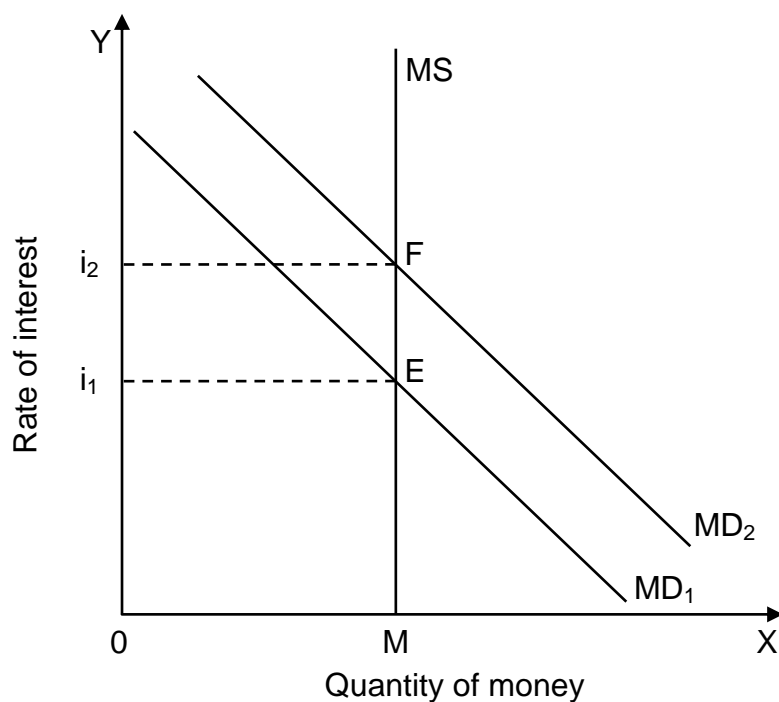

**Fig. 5.7. The effect of the increase in demand for money on the rate of interest**

**Interesting to know**

***Critical appraisal***

Thus we see that Keynes explained interest in terms of purely monetary forces rather than real forces like productivity of capital and thrift which formed the foundation stones of both classical and loanable fund theories. According to him, demand for money for speculative motive together with the supply of money determines the rate of interest.

He agreed that the marginal revenue product of capital tends to become equal to the rate of interest but the rate of interest is not determined by marginal revenue product of capital.

Moreover, according to him, interest is not a reward for saving or thriftiness or waiting but for parting with liquidity. Keynes asserted that it is not the rate of interest which equalizes saving with investment. But this equality is brought about through changes in the level of income.

According to Keynes, the rate of interest is determined by liquidity preference (i.e. demand for money) and supply of money. However, as we have seen, liquidity preference, especially demand for money for transactions motive, depends on the level of income. Now, when income increases, the liquidity preference curve (that is, the money demand curve) will shift to the right and, given the supply of money, a new equilibrium rate of interest will be obtained.

(to be continued)

(continued from p. 94)

Thus, at different levels of income there will be different money demand curves. As a result, at different levels of income, there will be different equilibrium rates of interest. Thus, we cannot know the rate of interest unless we know the liquidity preference curve, and also we cannot know the liquidity preference curve unless we know the level of income.

According to different levels of income, there will be different demand curves for money and therefore different rates of interest, given the supply of money. In this way we can derive a LM curve which indicates various combinations of interest rate and income at which money market is in equilibrium.

Thus, Keynes' analysis at the most helps us to obtain the LM curve which shows what the rate of interest will be at different levels of income and not any unique or particular rate of interest. Thus, the Keynesian theory, like the classical theory, is indeterminate. In the Keynesian case the supply and demand for money curves cannot give the rate of interest unless we already know the income level, in the classical case the demand and supply schedules for saving offer no solution until the income is known. Precisely the same is true of loanable funds theory. Keynes' criticism of the classical and loanable funds theories applies equally to his new theory.

## Glossary

**Money** is an important macroeconomic category due to which the analysis of inflationary processes, cyclical fluctuations, the mechanism of achieving equilibrium in the economy or coordination of the functioning of commodity and money markets is effected.

**Money market** illustrates how the demand for money and the supply of money interact to determine nominal interest rates.

**Price of money** is the nominal interest rate, the quantity showing how much money people hold.

**Money supply** is a fixed amount that doesn't change just because interest rates have changed. It shows the relationship between the amount of money supplied and the interest rate; because the central bank controls the stock of money, it does not vary based on the interest rate, and the money supply curve is vertical.

**Money demand** shows the relationship between the quantity of money demanded and the interest rate; the money demand curve is downward sloping.

**Banking system** is a set of banking institutions operating in a given country in relation to each other.

**Monetary policy** is a set of interconnected, coordinated measures aiming to achieve predetermined social goals, to regulate money circulation, which is carried out by the state through the central bank.

### Problems with examples of solutions

**Problem 1.** The following money demand function is given:

$$M_d = 0.6Y - 75i,$$

where income  $Y$  is given in crores and the interest rate  $i$  is denoted in percentage.

1. Calculate the demand for money when the income is 4 000 crores and the interest is 5 per cent.

2. Given that the level of income remains equal to 400 crores:

a) how will it affect the demand for money if the rate of interest falls to 2 per cent?

b) what will the demand for money be if the rate of interest rises to 8 per cent?

*Solution.* 1. When the rate of interest is 5 per cent,

$$M_d = 0.6Y - 75i.$$

Substituting the values of  $Y$  and  $i$  we have:

$$M_d = 0.6 \times 4\,000 - 75 \times 5 = 2\,025.$$

2a. If the rate of interest is 2 per cent,

$$M_d = 0.6 \times 400 - 75 \times 2 = 2\,250.$$

Thus, at a lower interest rate the demand for money to hold is higher.



2b. If the rate of interest is 8 per cent,

$$M_d = 0.6 \times 400 - 75 \times 8 = 1\,800.$$

Thus, at a higher rate of interest, people demand less money to hold.

**Problem 2.** For an economy, the following money demand function is given:

$$M_d = 0.5Y - 60i.$$

If the Central Bank of the country has set money supply equal to  $\leq 1\,520$  crores, calculate the rate of interest when money market is in equilibrium. Assume the level of income to be  $\leq 4\,000$  crores.

*Solution.* For money market to be in equilibrium

$$M_d = M_s,$$

$$0.5Y - 60i = 1\,520.$$

Given that  $Y = 4\,000$  crores,

$$0.5 \times 4\,000 - 60i = 1\,520,$$

$$60i = 480,$$

$$i = 8 \text{ per cent.}$$

**Problem 3.** The following money demand function of an economy is given:

$$M_d = 0.5Y - 60i.$$

Suppose the income of the economy is  $\leq 4\,000$  crores and the Central Bank has fixed money supply equal to  $\leq 1\,520$  crores. If at a time, the interest equal to 5 per cent annum prevails, will the money market be in equilibrium? Will the interest rate change?

*Solution.* Money market is in equilibrium when  $M_d = M_s$ .

The demand for money  $M_d = 0.5Y - 60i$ .

Given that the interest  $i = 5$  per cent and the income is  $\leq 4\,000$  crores,

$$M_d = 0.5 \times 4\,000 - 60 \times 5 = 1\,700 \text{ crores,}$$

$$1\,700 > 1\,520.$$

Thus, given the money supply of  $M_s$  is 1 520 crores at the 5 per cent rate of interest, the demand for money exceeds the supply of money.

This excess demand for money will lead to a rise in the interest to the level where the money demand equals the given money supply.

Usually the money stock in an economy is measured as one of the following alternative monetary aggregates:

$M_0$ , i. e., the *monetary base*, alternatively called *base money*, *central bank money*, or *high-powered money*. The monetary base is defined as fully liquid claims on the central bank held by the private sector, that is, currency (coins and notes) in circulation plus demand deposits held by the commercial banks in the central bank. This monetary aggregate is under the direct control of the central bank and is changed by *open-market operations*, that is, by the central bank trading bonds, usually short-term government bonds, with the private sector. But clearly the monetary base is an imperfect measure of the liquidity in the private sector;

$M_1$ , defined as currency in circulation plus *demand deposits* held by the non-bank general public *in commercial banks*. These deposits are also called *checking accounts* because they are deposits on which checks can be written and payment cards (debit cards) be used.  $M_1$  does not include currency held by commercial banks and demand deposits held by commercial banks in the central bank. Yet  $M_1$  includes the *major* part of  $M_0$  and is generally considerably larger than  $M_0$ : The measure  $M_1$  is intended to reflect the quantity of assets serving as media of exchange in the hands of the nonbank general public, i.e., the non-bank part of the private sector.

Broader categories of money include:

$M_2 = M_1$  plus savings deposits with unrestricted access and small-denomination time deposits. Although these claims may not be instantly liquid, they are close to it.

$M_3 = M_2$  plus large-denomination time deposits.

As we move down the list, the liquidity of the added assets decreases, while their interest yield increases. Currency earns zero interest. When in macroeconomic texts the term "money supply" is used, traditionally  $M_1$  or  $M_2$  is meant; there is, however, a rising tendency to focus on  $M_3$ . Along with currency, the demand deposits in the commercial banks are normally fully liquid, at least as long as they are guaranteed by a governmental deposit insurance (although normally only up to a certain maximum per account). The interest earned on these demand deposits is usually low (at least for "small" depositors) and in fact often ignored in simple theoretical models.

A related and theoretically important simple classification of money types is the following:

- 1) *outside money* = money that on net is an asset of the private sector;
- 2) *inside money* = money that is not net wealth of the private sector.

Clearly,  $M_0$  is *outside money*. Most money in modern economies is *inside money*, however. Deposits at the commercial banks is an example of inside money. These deposits are an asset to their holders, but a liability of the banks. Even broader aggregates of money (or "near-money") than  $M_3$  are sometimes considered. For instance, it has been argued that the amounts that people are allowed to charge by using their *credit cards* should be included in the concept of "broad money". But this would involve *double counting*. Actually you do not pay when you use a credit card at the store. It is the company issuing the credit card that pays to the store (shortly after you made your purchases). You postpone your payment until you receive your monthly bill from the credit card company. That is, the credit card company does the payment for you and gives credit to you. It is otherwise with a *payment card* where the amount for which you buy is instantly charged to your account in the bank. So:

*monetary base ( $M_0$ ): direct liabilities of the Central Bank (currency in circulation + bank reserves);*

*$M_1$ : currency in circulation + traveler's checks + checking accounts;*

*$M_2$ :  $M_1$  + savings accounts + money market accounts + small time deposits;*

*$M_3$ :  $M_2$  + large time deposits + eurodollars.*

*Bank lending* is the channel through which the monetary base expands to an effective money supply, the "money stock", which is considerably larger

than the monetary base. The excess of the deposits of the general public over bank reserves ("vault cash" and demand deposits in the central bank) is lent out in the form of bank loans, or government or corporate bonds, etc. The non-bank public then deposits a fraction of these loans on checking accounts. Next, the banks lend out a fraction of these and so on. This process is named the *money multiplier process*. And the ratio of the "money stock", measured as M1; say, to the monetary base is called the *money multiplier*.

Let:

CUR = currency held by the non-bank general public;

DEP = demand deposits held by the non-bank general public;

CUR/DEP =  $cd$ , the desired currency-deposit ratio;

RES = bank reserves = currency held by the commercial banks ("vault cash") plus their demand deposits in the central bank;

RES/DEP =  $rd$ , the desired reserve-deposit ratio.

Notice that the currency-deposit ratio,  $cd$ , is chosen by the non-bank public, whereas the reserve-deposit ratio,  $rd$ , refers to the behavior of commercial banks. In many countries there is a minimum reserve-deposit ratio required by law to ensure a minimum liquidity buffer to forestall "bank runs" (situations where many depositors, fearing that their bank will be unable to repay their deposits in full and on time, simultaneously try to withdraw their deposits). On top of the minimum reserve-deposit ratio, the banks may hold "excess reserves" depending on their assessment of their lending risks and need for liquidity.

To find the money multiplier, note that

$$M1 = CUR + DEP = (cd + 1)DEP, \quad (5.5)$$

where DEP is related to the monetary base, M0; through

$$M0 = CUR + RES = cdDEP + rdDEP = (cd + rd)DEP. \quad (5.6)$$

Substitution into formula (5.5) gives

$$M1 = (cd + 1) / (cd + rd) \times M0 = mmM0, \quad (5.7)$$

$$mm = (cd + 1) / (cd + rd), \quad (5.8)$$

where  $mm$  is the money multiplier.

## Questions for self-assessment

1. How is the level and the growth rate of the money supply (in the M0 sense, say) linked to:
  - a) the real variables in the economy (resource allocation),
  - b) the price level and the rate of inflation?
2. How can monetary policy be designed to stabilize the purchasing power of money and optimize the liquidity services to the inhabitants?
3. How can monetary policy be designed to stabilize the economy and smooth business cycle fluctuations?
4. Do rational expectations rule out persistent real effects of changes in the money supply?
5. What kind of regulation of commercial banks is conducive to a smooth functioning of the credit system and reduced risk of a financial crisis?

## Review questions

1. Is hyperinflation always the result of an immense growth in the money supply or can hyperinflation be generated by self-fulfilling expectations?
2. In Fig. 5.8, show the impact of selling bonds on the interest rate.

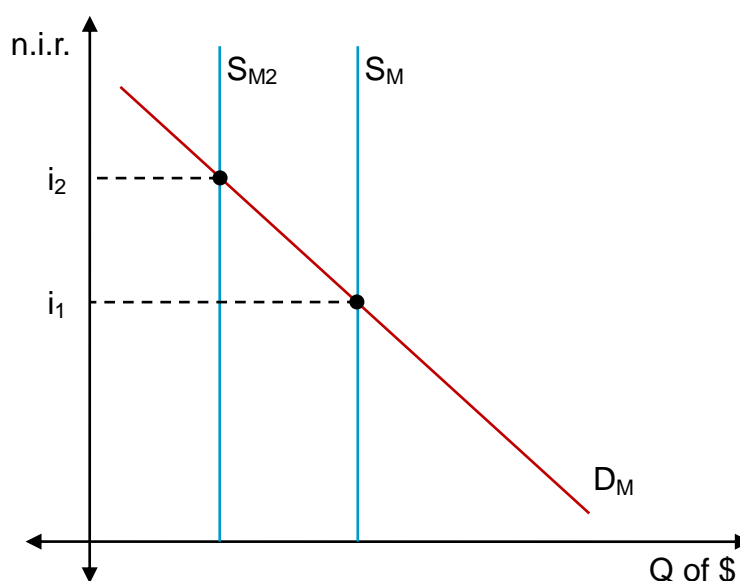

Fig. 5.8. The money market

3. If the money supply decreases, will bond prices increase, decrease, or stay the same? Explain.

4. Show the impact of inflation on interest rates using the money market. Explain why the change that you showed occurs.

### Tests

1. The mass of money that is offered to the market by institutions that have the right to create money is:

- a) the offer of national money;
- b) the monetary aggregate;
- c) the market currency;
- g) the monetary base.

2. Cash stored in banking institutions is:

- a) the monetary base;
- b) bank reserves;
- c) deposits;
- d) the money multiplier.

3. If the demand for money and the supply of money grow, then:

a) the equilibrium amount of money and the equilibrium interest rate will increase;

b) the equilibrium amount of money and the equilibrium interest rate will decrease;

c) the equilibrium amount of money will increase, and it is impossible to predict a change in the equilibrium interest rate;

d) the equilibrium interest rate will increase, and it is impossible to predict a change in the amount of money.

4. The greatest degree of liquidity is:

- a) jewelry;
- b) real estate;
- c) money in accounts;
- d) cash.

5. The required reserve ratio for a commercial bank is determined by:

- a) the ratio of the amount of the required reserves to deposits;
- b) the ratio of the amount of the required reserves to loans;
- c) the ratio of the money supply of the country and its velocity;
- d) the ratio of loans to the money supply of the country.

6. Monetary aggregates are:

- a) highly liquid financial assets that may be quickly converted to money;
- b) alternative measures of money supply;
- c) operations through which banks form the resources for conducting assets;
- d) savings accounts.

7. The money market is defined as:

- a) short-term credit operations, where the money supply and the demand for money determine the level of interest rates;
- b) long-term credit operations, where the money supply and the demand for money determine the level of interest rates;
- c) cash, where money supply and demand determine the interest rate level;
- d) money, where money supply and demand do not determine the interest rate level.

8. According to the classical model, the money market:

- a) leads to inflation;
- b) stimulates production growth;
- c) is an instrument for forming a general price level;
- d) affects the investment processes.

9. The transaction motive of the demand for money reflects the need for money for:

- a) the implementation of agreements (current payments);
- b) unexpected payments;
- c) repayment of loans;
- d) transfer payments.

10. Equilibrium in the money market occurs provided that:

- a) the demand for real cash balances absorbs the entire amount of money created by the banking system;
- b) the growth rate of the real income is equal to the growth rate of the monetary base;
- c) simultaneously with the increase in the monetary base and in proportion to it the discount rate will decrease;
- d) with an increase in real income, the demand for money as property proportionally increases.

Answers: 1a; 2b; 3c; 4d; 6b; 5a; 7a; 8c; 9a; 10a.

## 6. The inflation mechanism

Since modern money is a means of ensuring commodity relations, and they themselves have no value or this value is insignificant, it is established on the basis of comparative characteristics of the value of other goods, their representative value. If the quantity of money increases without a corresponding increase in the mass of goods, then, at a constant value of goods, the value of the monetary unit decreases, which means inflation. Since money is the equivalent of the value created in society, the additional money issued is, in fact, false. However, it is no different from full-fledged money, because it is issued by the same bank.

Therefore, being in circulation, it "dilutes" the value of the existing money, increasing its total mass. But such inequality cannot exist, because it will lead to a gap between price and money, that is, money won't perform its function as a measure of the value of goods. Therefore, in the process of circulation of goods a new equality between them is established, achieved by increasing the absolute value of the monetary expression of value (price). It is based on the lower value of monetary units than before, which means inflation of money. A rise in prices due to inflation of money, brings the prices of goods in line with the new standards of their measurement.

6.1. The essence and the main types of inflation.

6.2. The causes and effects of inflation. Antiinflationary policy.

**Key terms:** inflation, inflation rate, deflation, disinflation, antiinflationary policy, demand inflation, cost inflation, moderate inflation, galloping inflation, hyperinflation, hidden inflation, Fisher's equation.

### 6.1. The essence and the main types of inflation

One of the main indicators of macroeconomic instability, along with unemployment, is inflation.

The term "inflation" in relation to money circulation appeared in the middle of the 19th century in connection with the large issue of paper dollars (greenbacks) during the American Civil War (1861 – 1865). For a long time,



inflation was understood as the process of depreciation of money and growth of commodity prices, considering it a monetary phenomenon.

Modern inflation is associated not only with the fall in the purchasing power of money as a result of rising prices, but also with the general unfavorable state of economic development of the country. It is caused by the contradictions of the production process generated by various factors in the sphere of production and sales, as well as monetary circulation and credit.

The cause of inflation is the disproportion between accumulation and consumption, supply and demand, revenues and expenditures of the state, the money supply in circulation and the need of the economy for money.

Inflation is a steady increase in the general level of prices, resulting from a violation of macroeconomic equilibrium, when a significant part of the money supply was not provided with economic benefits.

Inflation can be measured using price indices (see section 2), determining the rate of price growth. The rate of price growth can be analyzed with the help of the price index, since its value shows how many times prices have increased (or decreased) in the economy over a certain period of time. Therefore, the price index is called the inflation index.

Inflation (from the Latin *inflatio* – inflation) is a noticeable steady increase in the price level. The process opposite to inflation is called deflation. The slowdown in inflation is called disinflation.

Inflation is a dynamic macroeconomic process that is calculated using price indices. Therefore, they are often called inflation indices. As an inflation index, two price indices are mainly used: the consumer price index (CPI) and the GDP price index, that is, the GDP deflator (Defl).

The consumer price index is an index reflection of the price of a typical market basket of domestic and imported consumer goods and services purchased in the domestic market of a country. In its calculation, compare the cost of a basket of goods and services of fixed composition in the current and base periods. There are two types of consumer price index. If the calculation process is based on the assortment set of goods in the base period, the Laspeyres index is obtained. If in the process of calculations the assortment set of goods in the current period is used, the Paasche index is obtained.

The Paasche index somewhat understates the inflation rate, since it does not take into account the assortment shifts in the current period relative to the base one. The Laspeyres index overstates inflation because it does not take into account the effect of replacing expensive goods with similar cheaper goods. To eliminate these differences, it is proposed to use the I. Fischer index, which is calculated as the geometric mean of the Laspeyres and Paasche indices:

$$I_t^F = \sqrt{I_t^L \cdot I_t^P}. \quad (6.1)$$

But calculating the Fisher index is quite time consuming. Therefore, this index is rarely used in practice. The Laspeyres index is most often used, since it is enough to take into account only the change in prices for its calculation. This index is used in Ukraine in calculating the consumer price index.

The GDP deflator is an index of prices for all goods and services produced in a country, both for the domestic market and for exports. According to statistical analysis, the GDP deflator is calculated as the Paasche index, that is, on the basis of the assortment of goods in the current period:

$$\text{Defl GDP} = \frac{\sum p_t^i \cdot q_t^i}{\sum p_{t-1}^i \cdot q_t^i} \cdot 100 = \frac{\text{GDP current price}}{\text{GDP prices of the base period}} \cdot 100. \quad (6.2)$$

Forecast accounts use a different formula to calculate the GDP deflator:

$$\text{Defl} = a \cdot \text{CPI} + (1 - a) \cdot \text{WPI}, \quad (6.3)$$

where  $a$  is the coefficient reflecting the share of consumer prices' influence on the GDP deflator;

CPI, WPI are forecasts of consumer and wholesale prices, respectively.

Each of the above price indices has its advantages and disadvantages. The main advantage of the consumer price index over the GDP deflator is the relative simplicity and efficiency of calculation. Without much difficulty, statistics can determine it not only for annual, but also for quarterly and

monthly time intervals. Due to the complexity of calculations, the GDP deflator is calculated no more often than once a quarter. However, despite this, it has a very important advantage over CPI, since it covers not only consumption, but also other components of GDP. Statistical analysis shows that there is a close relationship between the GDP deflator and the consumer price index. But due to significant increases in import prices, CPI can grow faster than the GDP deflator.

The opposite process of inflation is deflation – a decrease in the overall price level (negative growth). In the modern economy, this phenomenon is rare and short-lived and usually seasonal. For example, grain prices tend to decline immediately after harvest. Long-term deflation is characteristic of very few countries. Today, an example of deflation is the Japanese economy (within -1 %). The phenomenon of slowing or decreasing inflation is called disinflation. In Ukraine, the phenomenon of disinflation occurred, for example, from 1994 (10 256 % per annum) to 1997 (10 % per annum).

The causes of inflation are as follows:

growth in public spending, which leads to emission of money;

surplus of the money supply due to massive lending;

a monopoly of large firms on setting the prices and determining their own costs of production, especially in the raw material industries;

a monopoly of trade unions, which limits the ability of the market mechanism to determine an acceptable level of wages for the economy;

reduction of the real volume of national production, which at a stable level of the money supply leads to an increase in prices, as a smaller volume of goods and services corresponds to the former amount of money.

Inflation is a multifactorial, complex socioeconomic phenomenon, so it can be classified according to different classification characteristics.

1. According to the rate of price growth:

1.1. Moderate inflation is measured by percentages per year, and its level is 3 – 5 % (up to 10 %). This type of inflation is considered normal for the modern economy and is even considered an incentive to increase output.

1.2. Galloping inflation is also measured as a percentage per year, but its rate is expressed in double figures and is considered a serious economic problem (up to 50 %).

1.3. Hyperinflation is measured by percentages per month and can be 200 percent or more per year (note that the calculation of inflation for the year uses the formula "compound interest"), which is observed in many developing countries and countries with transitive economies.

Hyperinflation can be measured in percentages per week and even per day, with the levels of 40 – 50 % per month or more than 1,000 % per year. A classic example of hyperinflation is the situation in Germany in January 1922 – December 1924, when the growth rate of the price level was 1 012 %.

2. According to the forms of manifestation:

2.1. Open (explicit) inflation is manifested in the observed increase in the overall price level.

2.2. Suppressed (hidden) inflation occurs when prices are set by the state, and are at a level lower than the equilibrium market (established by the ratio of supply and demand in the commodity market). The main manifestation of hidden inflation is the shortage of goods.

3. Depending on the reasons of occurrence:

3.1. Demand inflation caused by a shortage of goods.

3.2. Cost (supply) inflation caused by higher resource prices.

4. Based on the scale of distribution:

4.1. Regional.

4.2. National.

4.3. National and regional.

4.4. Worldwide.

5. Based on the ability of the state to influence inflation:

5.1. Controlled.

5.2. Uncontrolled.

6. Based on the ability of the economy to adapt to the rate of price growth:

6.1. Balanced.

6.2. Unbalanced.

7. According to the degree of foresight:

7.1. Expected (predicted, forecasted) is the inflation predicted by economic subjects on the basis of information.

7.2. Unexpected (unforeseen, unpredictable).

In macroeconomic analysis, there are two theories, according to which the influence of inflation expectations on the behavior of economic subjects is

considered. These are adaptive expectations theory and rational expectations theory. The theory of adaptive expectations proceeds from the fact that economic entities form their inflation forecasts based on the analysis of information about the development of economic processes in the past. In the theory of rational expectations, economic subjects form their inflation forecasts based on both the information about the past and future development of economic processes. But it should always be borne in mind that inflation is a complex phenomenon, so forecasting inflation expectations requires special knowledge and skills from economic subjects.

Let us consider in more detail the inflation of demand and inflation of supply (costs).

Demand inflation is an increase in the overall price level, which is explained by the leading increase in aggregate demand AD compared to aggregate supply AS in the conditions of a marginal production potential (Fig. 6.1).

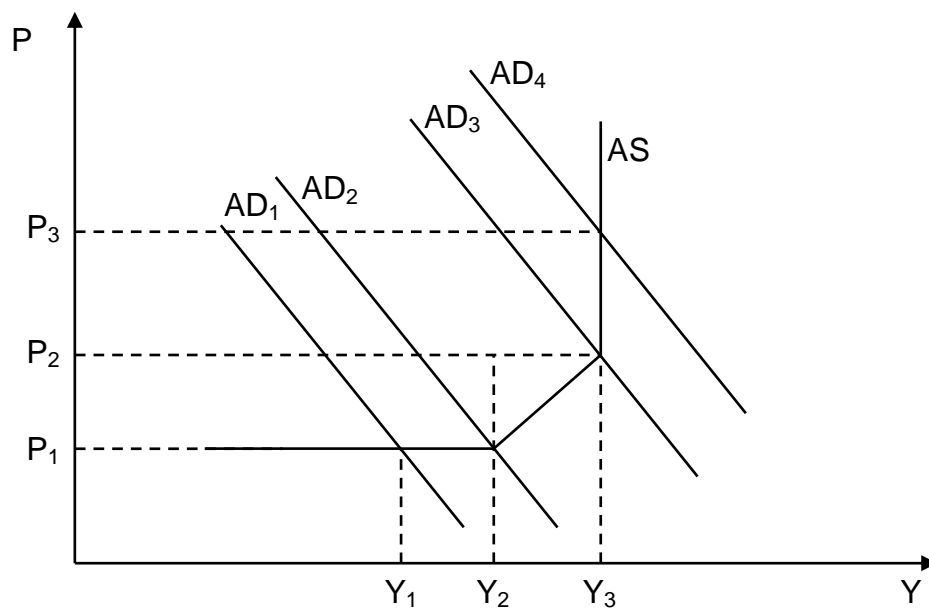
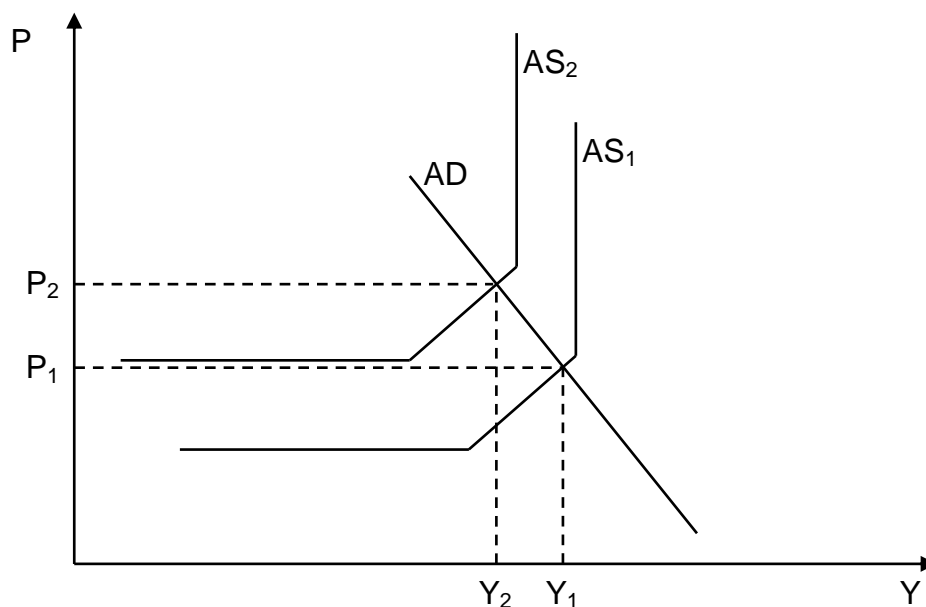

Fig. 6.1. Demand inflation

If the aggregate supply of AS is constant, then an increase in the aggregate demand of AD on its horizontal segment will not lead to inflation and therefore stimulation of AD is desirable. On the upward segment of the AS curve, the economy is underemployed, that is, it has certain reserves of production capacity. Therefore, an increase in aggregate demand from AD<sub>1</sub> to AD<sub>2</sub> will not cause an increase in the price level, and an increase in

aggregate demand from  $AD_2$  to  $AD_3$  will cause a slight increase in the price level from  $P_1$  to  $P_2$ . Inflation in this segment is called premature. On the vertical segment of the curve, the economy is in full (or close to it) employment, almost all production capacities are loaded, so any increase in aggregate demand from  $AD_3$  to  $AD_4$  will lead to an inflationary increase in the price level from  $P_2$  to  $P_3$ .

Cost (supply) inflation is an increase in the overall price level resulting from an increase in unit costs and accompanied by a decrease in aggregate supply (Fig. 6.2).



**Fig. 6.2. Inflation of costs**

The main sources of cost inflation are rising prices for raw materials, fuel and components, an increase in nominal wages and indirect taxes. Graphically, cost (supply) inflation can be shown by moving the curve  $AS_1$  to  $AS_2$  to the left with the unchanged aggregate demand curve  $AD$ . This shift can be caused by an increase in the expected rate of inflation, which leads to higher wages. Higher wages, in turn, accelerate inflation. Thus, the price level increases from  $P_1$  to  $P_2$ , and the volume of production decreases from  $Y_1$  to  $Y_2$ . So, with cost inflation, price and output change in opposite directions: prices rise and output falls. Typically, cost inflation occurs in the form of stagflation.

Inflation of demand and inflation of costs can generate each other and then they cause an inflationary spiral "prices-wages" (Fig. 6.3).

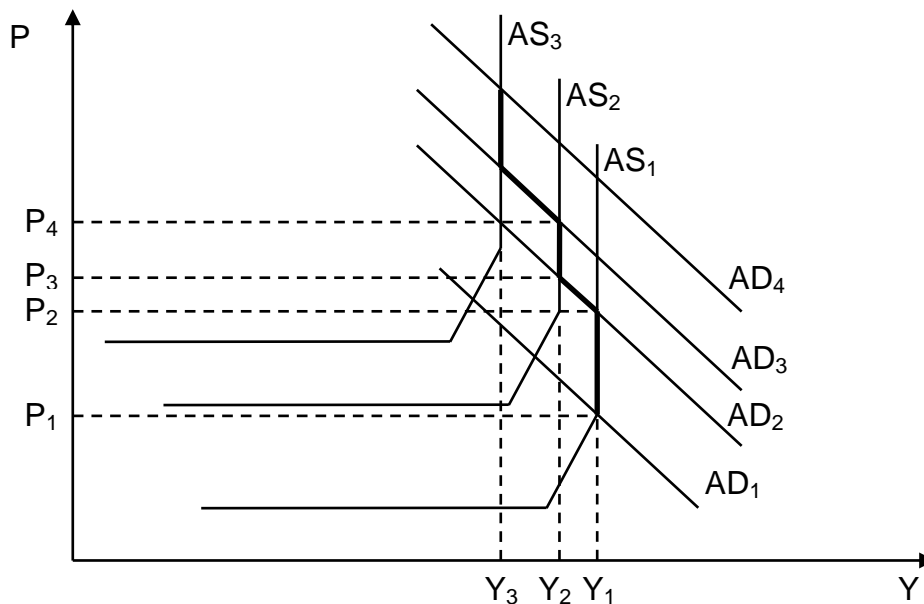

Fig. 6.3. The inflationary spiral "prices-wages"

As a rule, this spiral begins with demand inflation, which forces workers to advocate for higher wages ( $AS_1, AD_1, AD_2$ ). Higher wages will cause supply inflation ( $AD_2, AS_1, AS_2$ ), prices will rise again, the level of production will decrease ( $AS_2, AD_2, AD_3$ ), there is demand inflation, and so on. As can be seen from the figure, the price gradually increases, while the level of production of goods and services is reduced.

## 6.2. The causes and effects of inflation. Antiinflationary policy

There are two main theories that explain the causes of inflation: Keynesian and monetarist. Keynesian theorists analyze only the inflation of demand that occurs in full employment. But nowadays, inflation occurs in conditions of underemployment. In addition, modern inflation is also affected by cost inflation and expectation inflation. Proponents of monetary theory see the cause of inflation in the excessive amount of money in circulation compared to the cost of goods and services. The theoretical basis of their conclusions is the quantitative theory of money, as well as the reference to the fact that there is a significant correlation between the money supply and inflation. Under these conditions, an increase in the money supply will cause an increase in aggregate demand and the price level.

In fact, modern inflation can be explained by a number of factors, which are conditionally divided into three types:

1. Factors of demand inflation. Since inflation is caused by excessive aggregate demand, so there are:

factors of excessive government demand (emission financing of the budget deficit);

factors of excessive private demand (excessive demand, faster growth of income compared to GDP growth, etc.);

factors of excessive foreign demand for domestic goods and services (faster growth of exports compared to imports).

2. Cost inflation factors also increase the average cost of producing goods and services. They are divided into:

domestic (an increase in prices for intermediate consumption products; faster growth of wages compared to labor productivity; an increase in indirect taxes, etc.);

external, which are implemented through import.

3. Inflationary expectation. The actions of economic subjects according to their expectations lead to an increase in prices. For example, enterprises raise prices in advance, etc.

The socioeconomic consequences of inflation include a decline in living standards and real incomes; depreciation of financial assets; violation of relations between lenders and borrowers; reduced motivation to invest; redistribution of income between the private sector and the state.

Losses from inflation for the population depend on whether they are predictable and how the expectations of economic subjects are formed. Naturally, inflation is divided into predictable and non-predictable. In the case of expected or projected inflation, the correlation between inflation and interest rates for correction of nominal income can be shown using the Fisher equation:

$$i = r + B, \quad (6.4)$$

where  $i$  is the nominal interest rate;

$r$  is the real interest rate;

$B$  is the expected inflation rate.

For example, if economic subjects expect annual inflation of 7.5 %, they will correct their nominal incomes: they will plan an increase in wages, an increase in rent payments and bank interest by 7.5 %.



Inflation also negatively affects the interests of the state. The main factor in this case is time, since taxes are paid to the state budget later than they are charged, that is, already depreciated money is paid to the budget. The government can also pay its debts with depreciated money. The result is the so-called inflationary taxation effect or Oliver – Tanzi effect, the essence of which is that any inflation reduces the tax burden. The state seeks to avoid this effect and resorts to increasing the frequency of advance payment of taxes and other measures.

The increase in inflation caused by additional money emission forces economic entities to pay the so-called inflation tax. This tax is not accepted by law. It represents the costs incurred by those who hold the money on hand in the form of cash:

$$IT = B^* \times (M/P), \quad (6.5)$$

where IT is the inflation tax;

$B^*$  is the inflation growth rate per year;

$M/P$  is the level of real cash balances.

The inflation tax also includes seigniorage that is the income that the state receives from the issue of additional money into circulation.

In the late 60s of the twentieth century, the concept of stagflation was introduced in the economy, which means the simultaneous existence of inflation and unemployment (stagnation of production). Graphically, stagflation is shown by shifting the short-term Phillips curve to the right and up.

Analyzing the Phillips curve (section 3) in the short and long term, we can draw the following conclusions about the stabilization policy of the state:

the choice between inflation and unemployment can be made only in the short term, because in the long term there is no such choice;

Keynesian methods of stimulating demand in order to achieve full employment are imperfect because they generate inflation. The government can fight unemployment only if its actual level does not exceed the natural level, because otherwise it can provoke an increase in inflation;

the optimal policy goal is "zero inflation", since if the actual unemployment rate is lower than the natural rate, the rate of inflation increases, which negates the benefits of high employment;

the policy of "zero inflation" is short-lived and quite painful, as a result of deflationary policies there is a decline in production, an increase in unemployment until people begin to reduce their inflation expectations.

In accordance with the above conclusions, it is possible to make adjustments to the definition of the category of the natural unemployment rate. The natural unemployment rate, according to M. Friedman, is a level of unemployment that does not increase inflation. The natural unemployment rate corresponds to a macroeconomic equilibrium where the expected inflation is equal to the actual one.

Macroeconomic policy that aims to stabilize the overall level of prices, ease the inflationary severity, achieve a correspondence between the rate of increase in the money supply and the rate of increase in goods, is called antiinflationary policy.

Antiinflationary policy includes adaptive (tactical) and active (strategic) methods.

Adaptive methods can be carried out only when the inflation rate does not exceed 20 – 30 % per year. These include:

- gradual restriction of money supply;
- indexation of monetary incomes of the population;
- price and revenue regulation;
- stabilization of inflation expectations, etc.

Active methods are used in conditions of hyperinflation and involve a sharp reduction in the supply of money. These include:

- direct monetary funds;
- control over the money supply;
- prohibition of issue financing of the state budget;
- control of the money supply through operations in the open market;
- implementation of the confiscation monetary reform.

Antiinflation policies also include measures against demand inflation and supply inflation.

Measures against demand inflation are:

- reducing government spending;
- an increase in taxes;
- reducing the budget deficit;
- implementation of tight monetary policy;
- stabilization of the exchange rate.

Measures against cost inflation (proposals) are:

- limiting the increase in factor incomes, and prices;
- restriction of monopolies and protection of competition;
- reduction of taxes for individuals and legal entities;
- strengthening motivation to work through changes in social policy.

The choice of specific measures to combat inflation can be determined by the nature of inflation and for each country it has specific features. Depending on the causes of inflation, the complex of combating is determined.

The poverty index is used to assess the effectiveness of the state's economic policy:

$$\text{Poverty index} = \text{unemployment rate} + \text{inflation rate.} \quad (6.6)$$

A special primary factor of inflation is inflation expectations, which arise in conditions of chronic inflation. Expecting a certain level of inflation by inertia, enterprises raise the prices of their goods in advance, commercial banks raise the interest on the loan, hired workers demand an increase in wages in advance.

In conditions of high inflation expectations, money becomes "hot", from which economic entities try to quickly get rid of, which reduces the demand for money and accelerates the speed of its rotation. Statistics show that the higher inflation in the previous period, the higher the rate of circulation of money and inflation in the next period.

Despite the large number of primary factors of inflation, their impact on the overall growth of prices is ultimately reflected through the dynamics of the elements of the quantitative equation: the money supply, the speed of circulation of money, real GDP. Therefore, they can be called the final factors of inflation. With their help, inflationary processes in the production, financial and foreign economic spheres are realized at the macro level through the general growth of prices. Therefore, whatever the primary factors arise in the economy, prices rise only to the extent that these factors affect the money supply, the rate of circulation of money and real GDP.

Inflation management involves the use of comprehensive measures designed to eliminate (or mitigate) the factors of inflation and overcome its consequences. Such a set of measures should combine a slight increase in prices with stabilization of incomes. In this aspect, antiinflation and pro-inflation policies of the government are used.

Antiinflation policy is a set of regulatory instruments aiming to reduce the level of inflation. For antiinflationary regulation, restricted (monetary) economic policy is used (reducing the budget deficit, limiting credit expansion, raising taxes, minimizing benefits and transfer costs, restraining monetary emission). According to monetarist views, targeting is used, for regulation of the rate of growth of the money supply in accordance with the rate of GDP growth.

Pro-inflation policy is a set of instruments of state regulation designed to adapt the economy to the existing level of inflation in the case when it cannot be avoided or reduce the price level in the country. In the process of pro-inflation regulation, adaptive (Keynesian) policies are used (stimulation of effective demand by providing large public orders to private firms; regulation of prices and incomes, which links wage growth with price growth through income indexation; use of government borrowing).

In general, the choice of a policy can be illustrated as follows. The deviation of equilibrium output from its natural level causes inflationary and deflationary (recession) gaps, which reflect the disparity between the actual expenditure of the economy and the expenditure that would have occurred in full employment.

In modern practice, there are such directions of antiinflation policy as: deflationary policy (demand management) and income policy (cost management).

The essence of deflationary policy (Fig. 6.4) is the impact on the individual elements of effective demand in order to limit it and the formation of a new correlation of supply and demand for both goods and money. In practice, monetary, structural, investment and fiscal policies are used to regulate demand.

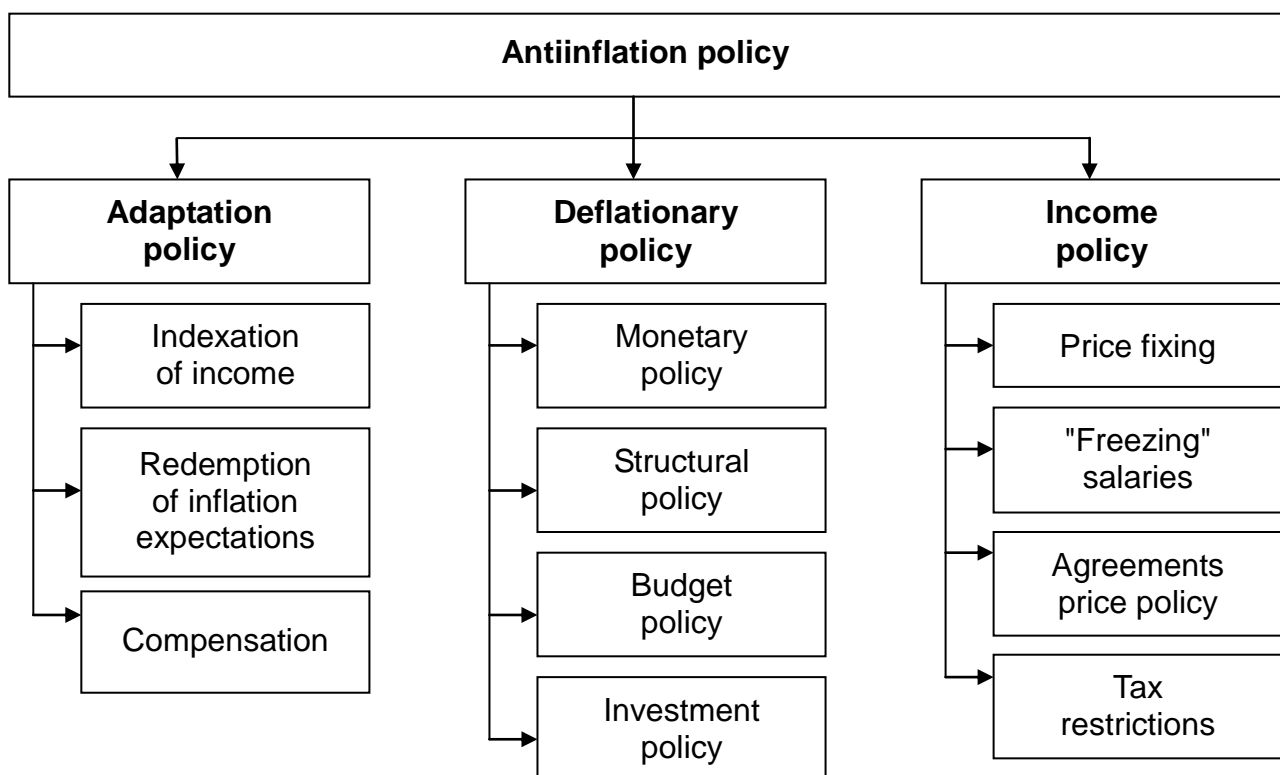

Fig. 6.4. The structural composition of antiinflation policy

The essence of income policy is to directly limit the growth of prices and incomes, and above all wages. Income policy has a double impact on inflation. By limiting the increase in prices and wages, revenue policy reduces the increase in the cost of production of goods whose price includes these values. This inhibits the self-development of inflationary processes. At the same time, restraining wage growth limits effective demand, which has a negative impact on the economy. Therefore, income policies are often used with deflationary policies. A peculiar feature of the income policy is that it can be implemented not only in the economy as a whole, but also within individual sectors of the economy, in particular in the state. The regulation of prices and wages in the public sector has a double effect on inflationary processes, restraining the increase in the general price level and stabilizing the state budget.

Among the measures of antiinflationary policy, of great significance are measures aiming to adapt to inflation rather than combat it. These include adaptation policies that are implemented through income indexation. Inflation-induced price increases inevitably lead to a decrease in the real income of the population, especially those segments of it that cannot protect themselves from the depreciation of money. In this regard, there is a need for full or partial indexation of income through an increase in wages of employees of budgetary institutions, pensions, cash payments and savings of the population, taking into account the growth of prices. Such indexation does not eliminate inflation, but only mitigates its negative impact, although it can turn into a powerful inflationary factor if carried out in a budget deficit, which is financed by monetary emission.

Consequently, the implementation of antiinflationary policies depends on the ratio of many economic processes and degree of their activity. The greatest efficiency can be achieved only if all possible ways are used in fighting with inflation in a comprehensive manner.

A separate type (method) of state policy in the field of inflation control is the state regulation of prices. There are several typical goals, each of which corresponds to certain methods of state influence on pricing:

- prevention of the devastating impact of prices on the economy;
- controlling inflation through income policies;
- ensuring access to essential goods for all segments of the population, regardless of the level of income;

- protection of the domestic market from the negative impact of external competition;
- containment of monopolies and ensuring a competitive environment in the market.

The main forms of state price regulation include: price level restriction; tax regulation; subsidies. All methods of state regulation of prices are divided into direct (direct intervention of the state in the pricing process) and indirect (change of pricing conditions).

The main direct methods of state price regulation include: 1) introduction of marginal profitability standards; 2) changes in import duty rates; 3) preferential lending and taxation; 4) differentiation of commodity tax rates, etc.

The main indirect methods of state price regulation include: 1) agreements on prices; 2) providing grants and certain services; 3) "freezing" (locking) the prices; 4) the introduction of maximum levels of trade and sales allowances; 5) declaration of changes in prices; 6) application of fixed prices; 7) establishment of marginal levels of prices.

Thus, government regulation implies a wide range of forms and methods of influence on the general level of prices in the country, the reasonable choice of which provides effective overcoming of problems and consequences of inflation.

## **Glossary**

**Antiinflation policy** is a set of regulatory measures of the government in the field of public finance and in the monetary sphere, aiming to curb inflation and improve the balance of payments

**Deflation** is a decline in the overall level of prices for goods and services; the opposite process of inflation.

**Deflationary policy** is a set of regulatory measures of the government in the field of public finance and monetary sphere, designed to influence demand.

**Demand inflation** is a violation of the macroeconomic equilibrium between aggregate supply and aggregate demand, which manifests itself in a violation of the demand side.

**Inflation** is a long-term sustainable increase in the overall level of prices for goods and services.

**Inflation of costs** is a type of inflation characterized by an increase in the prices of resources and factors of production, and the resulting increase in the costs of production and circulation, as well as an increase in the prices of manufactured products.

**Inflationary spiral** is a process of interdependent price and wage growth in which price increases necessitate wage increases and wage increases lead to price increases.

**Revenue policy** is an integral part of social policy designed to solve two main tasks: providing direct assistance to the most vulnerable segments of the population through the social security system and neutralizing the inflationary depreciation of incomes and savings of the population.

### **Questions for self-assessment**

1. How can inflation be defined?
2. What is deflation and disinflation?
3. Name the types of inflation according to different classification criteria.
4. What are the main causes of inflation?
5. What is the difference between demand inflation and cost inflation?
6. How is the rate of inflation determined?
7. What are the main factors of inflation?
8. What are the main socio-economic consequences of inflation?
9. What does the Fisher's equation show?
10. What are the features of adaptive and active means of antiinflation policy of the state?

### **Review questions**

1. Construct a graphical interpretation of the Phillips curve. What processes can be explained by moving along this curve? What are the possible shifts of this curve? Explain.

2. Determine what type of inflation is illustrated on the graphs:

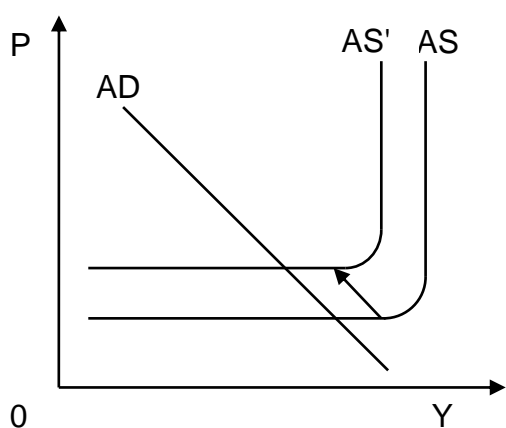

A)

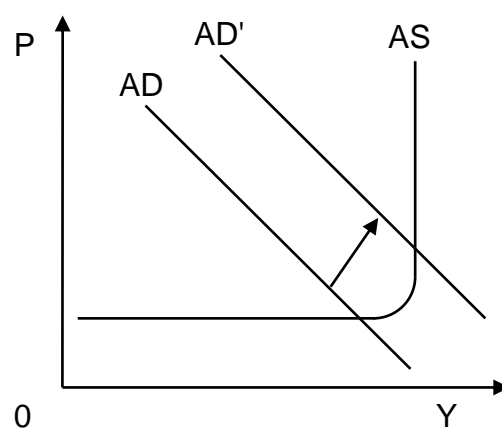

B)

What are the factors that cause the situation illustrated on the graphs?

### Tests

1. If the price level of goods and services is reduced by 50 %, the value of money:

- a) will not change;
- b) will double;
- c) will be reduced by half;
- d) will increase fourfold.

2. Demand inflation can occur in the case of:

- a) rising commodity prices;
- b) growth of public spending;
- c) structural changes in the economy;
- d) increase in money supply.

3. Which of the following is unrelated to the inflation of production costs:

- a) employment growth;
- b) growth of the cost of expenses per unit of production;
- c) nominal interest rate increase;
- d) growth of nominal salary.

4. Projected inflation:

- a) makes it possible to correct nominal incomes of the population;
- b) appears in public spending;



c) redistributes wealth from lenders to borrowers;

d) correct answers are a) and b).

5. Inflation tax is:

a) seigniorage;

b) expenses of the owners of money as a result of reducing the real value of cash balances;

c) regressive tax;

d) all answers are correct.

6. If nominal income increased by 8 %, and the price level increased by 10 %, the real income:

a) increased by 2 %;

b) increased by 18 %;

c) decreased by 2 %;

d) decreased by 18 %.

7. In country A, the price index was 100 % in 2000, 112 % in 2001, 123 % in 2002, 129 % in 2003. Then the rate of inflation rose by:

a) 12 % in 2001, 23 % in 2002, 29 % in 2003;

b) 0 % in 2001, 11 % in 2002, 6 % in 2003;

c) 12 % in 2001, 10 % in 2002, 5 % in 2003;

d) 0 % in 2001, 23 % in 2002, 13 % in 2003.

8. The rate of inflation on the modern Phillips curve depends on:

a) the expected inflation;

b) the situations where the actual unemployment rate deviates from the natural level;

c) supply shocks;

d) all answers are correct.

9. Antiinflation measures are carried out only in the conditions of:

a) open inflation;

b) hidden inflation;

c) open and hidden inflation;

d) hidden inflation of demand.

10. The wage-price inflation spiral occurs with rising:

a) wages;

b) prices;

c) the rate of inflation;

d) wages forming an increase in prices.

Answers: 1b; 2b; 3a; 4a; 5b; 6c; 7a; 8b; 9c; 10d.

## 7. Household consumption

Macroeconomic analysis includes the theory of consumption and savings. Consumption is the use of goods and services to satisfy needs. Consumption is considered to be the final stage of social production and depends on the size of income and its distribution. Consumption is the function of income and, in addition, the psychological factor that uses indicators of average and marginal propensity to consume, has a significant influence on the amount of consumption. In addition to the income level, other factors also influence consumption: inflation, wealth, interest on loans and a possibility of obtaining a loan.

In the Keynesian concept, consumer behaviour is interpreted in a fundamentally different way. Firstly, the value of income acts as an exogenous parameter. Secondly, the object of consumption depends only on the current disposable income. Thirdly, the distribution of income for consumption and savings depends on the preference of the consumer: traditions, prevailing worldview, etc. J. Keynes formulated the dependence of consumption on the value of current disposable income as a basic psychological law: if income increases, people tend to increase their consumption, but less than income grows. The Keynesian function of consumption and the function of saving correspond to the basic psychological law.

7.1. Consumption.

7.2. The Keynesian model of consumer behaviour.

**Key terms:** household, consumption, savings, consumption function, average propensity to consume, marginal propensity to consume, Keynesian theory of consumption, consumption factors, Lorenz curve.

### 7.1. Consumption

*A household* is an association of individuals who jointly engage in economic activities and have a common budget.

*The key household attributes are:*

- the general (full or partial) use of the budget by its members;
- the constant total consumption;
- the general household.

A household, unlike a family, can consist of one person.

In the national economy, households perform a number of important functions: reproduction of human capital, ownership of productive resources and supply of these resource in the respective markets; forming the consumer demand; consumption, savings, investment, etc.

Households account for the bulk of consumer spending. Households consume private goods that are bought and public goods provided by the government.

*Household consumption* is household spending on consumer goods and services.

Consumption expenditures depend on the household income.

Household income is generated through the sale of production factors that are owned by households: labour, capital, natural resources, and entrepreneurial ability.

The process of generating households' income and expenses can be considered using a simplified model of the economic circulation that in a private closed economy explains the interaction of only two entities of the economic system: households and enterprises, and does not reflect government intervention and any ties with the outside world (Fig. 7.1).

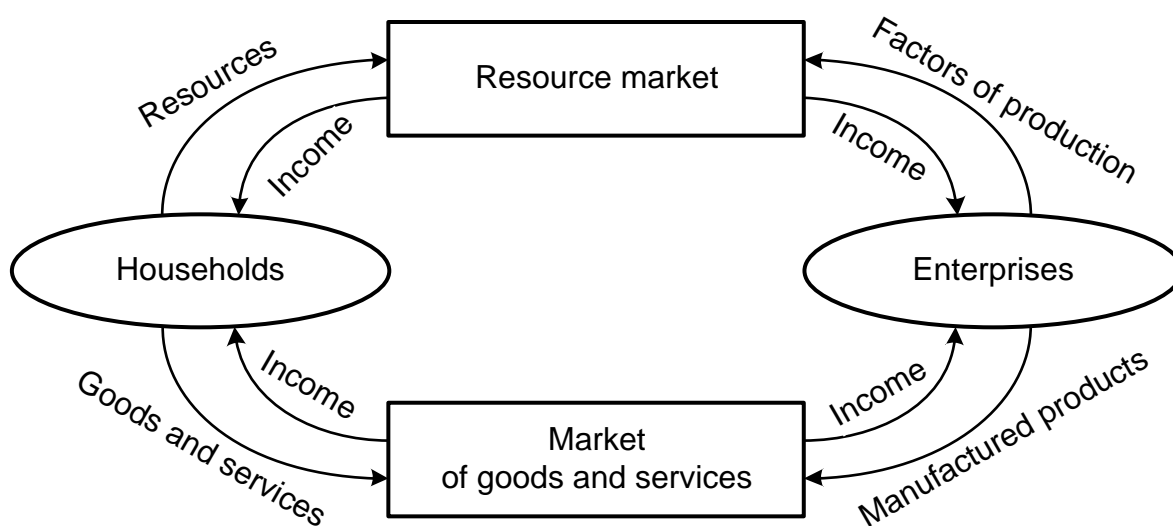

Fig. 7.1. **The simplified model of economic circulation**

According to the model, households direct their income to consumption – purchasing goods and services. In the market of goods and services, enterprises sell consumer goods and services and households buy them at

the expense of their income. The sum of household expenditures in this market determines their consumption that can be called private consumption.

In the resource market, households that own all economic resources directly or indirectly (through ownership of capital) make their offer and enterprises buy these resources for production. Enterprises bear the expenditures on resources: wages, rents, capital and entrepreneurial profit. Revenues, or income, from selling finished products are formed at the expense of consumer spending. The "income-expense" and "resource-product" flows are endlessly repeated. This means that for the closed private economy without government intervention, the value of total production in monetary terms is equal to the total income of households, i.e. their personal income.

For an economy with the government participation, *personal household income* can be determined by the formula:

$$Y = Z + EP + AP + Tr, \quad (7.1)$$

where Y is personal income;

Z is employees' salary;

EP is mixed income;

AP is income from assets;

Tr is social transfers.

The first two components of personal income are called income from *labour activity* or *labour income*. *Asset income* is a property income. Such income includes dividends, interest rates, rent. Social transfers cover income that is not earned, but received: pensions, scholarships, unemployment benefits, subsidies, etc. Transfers are paid by the government.

Households do not receive all their income. Part of the earned income is given back to the state in the form of individual taxes – for example, income tax. After-tax income is called *personal disposable income*. It is the income that households manage.

As it is already known, personal income and personal disposable income can be calculated differently (section 2 "Macroeconomic indicators in the system of national accounts", subsection 2.3 "The main macroeconomic indicators of income. National wealth").

Consumption is a priority to use personal available income. At the same time, in each current period, households do not direct all their available income to consumption – they save a certain part of it.

Savings are a part of income that is not currently consumed, or deferred consumption. Savings are used by households to regulate their spending on consumption over time.

The household decision on saving part of the income is determined by the following reasons:

- protection of oneself from unforeseen circumstances – "for a rainy day" (illness, accident, unemployment, etc.);
- financing planned big-budget purchases;
- forming savings for investments in their own business;
- children's education;
- desire to leave an inheritance;
- others.

So, personal disposable income of households is allocated for consumption and savings:

$$Y_d = C + S, \quad (7.2)$$

where  $Y_d$  is personal disposable income;

$C$  is consumption;

$S$  is savings.

Household income distribution is influenced by such factors as:

- the value of personal disposable income – the larger it is, the greater is consumption;
- accumulated wealth that households have at their disposal. The larger it is, the higher the consumption and less household savings, since the incentive to further accumulate wealth is weakening;
- a change in the price level – an increase in the price level contributes to an increase in savings, since an increase in prices reduces the purchasing power of money;
- household expectations that future money income will increase their consumption;
- household expectations regarding the future commodity deficit that can increase consumption and reduce savings;
- the level of taxation which equally affects both consumption and savings, since rising taxes reduce consumption and savings, and reduction, on the contrary, increases them;
- traditions, etc.

At the macro level, that is, on the scale of the entire economy of the country, the share of the available household income that is directed to consumption depends on the level of differentiation of personal income. *Differentiation of income* (from the Latin *differentia* – difference) is the difference in the level of cash income of different layers and groups of the population.

To assess the level of differentiation of household incomes and the resulting economic inequality of the layers and population groups, different methods and indicators are used. Most commonly these are the Lorenz curve, the Gini coefficient and the decimal coefficient.

*The Lorenz curve* is the graph of the actual distribution of income between families with different incomes in comparison with a uniform distribution. It is built by applying the indicators of the total percentage of the population (for example, families) and the total percentage of income, from the lowest to the highest. Complete equality will be represented by a straight line that goes between the axes at an angle of  $45^\circ$ . The degree of deviation from  $45^\circ$  represents the degree of inequality in the distribution of income.

For example in Fig. 7.2, on the horizontal axis, the entire number of families (households) divided into five equal groups (20 % each) is set, and on the vertical axis, five equal shares (20 %) of the total personal income are indicated. The theoretical possibility of the existence of absolute equality in the distribution of income between individual groups of families makes the bisector of the angle formed by the axes clear. In Fig. 7.2, it is shown with a dashed line. With equal incomes, if the distribution corresponded to the bisector, each percent of families would receive an adequate percentage of income. That is, 20, 40, 60, 80, 100 % of families would receive 20, 40, 60, 80, 100 % of the total amount of personal income, respectively. However, in fact, any percentage of total income corresponds to any percentage of families. This actual situation is reflected by the Lorenz curve that has the form of a concave curve.

According to Fig. 7.2, the first 20 % of families receive less than 10 % of the total income; 40 % of families – about 15 %; 60 % of families – about 30 %; 80 % of families – less than 60 %. The remaining 20 % of families receive over 40 % of the total income. The area between the bisector and the Lorenz curve represents the degree of the income inequality. The magnitude of this inequality is determined using the *Gini coefficient*, which is the ratio of the area between the real curve and the line running at an angle of  $45^\circ$  to the area under the line going at an angle of  $45^\circ$ .

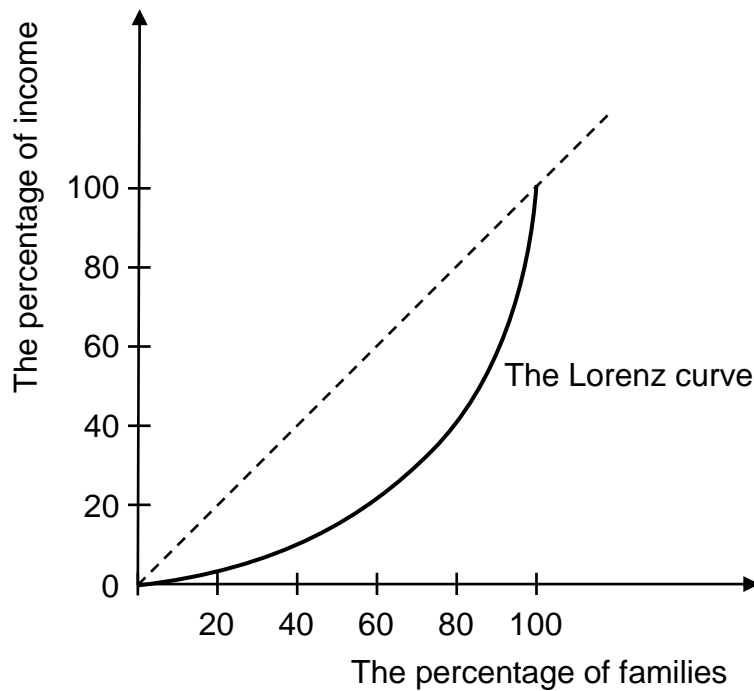

Fig. 7.2. **The Lorenz curve**

The decimal coefficient (from the Latin *decem* – ten) shows the ratio of the total income of 10 % of the richest population to the total income of 10 % of the poorest people. It is calculated like this: the population is divided into ten parts and each person's income is calculated. Then they take the two extreme parts: ten percent of the richest and the same percent of the poorest population. Then the first is divided into the second and the desired coefficient is got.

This coefficient determines the limit beyond which stability ends and the zone of instability begins. It is fraught with danger both for power and society. The value of this coefficient in different countries varies from 5 : 1 to 15 : 1. The situation is recognized as stable if the decimal ratio is below the 10 : 1 mark.

So, the main factor that determines consumption is the personal disposable income of households. Consumption is directly dependent on the amount of income. This dependence is called *the function of consumption*:

$$C = c_0 + c'(Y - T + TR), \quad (7.3)$$

where C is consumer spending;

$c_0$  is autonomous consumption, the amount does not depend on the size of the distributed income;

$c'$  is marginal propensity to consume (see below);

Y is personal income;

T is tax deduction;  
TR are transfers;  
( $Y - T + TR$ ) is distributed income, it is denoted as  $Y_d$ .

Taking into account the last remark, the formula takes the form:

$$C = c_0 + c'Y_d \quad (7.4)$$

The graphical interpretation of the consumption function is shown in Fig. 7.3.

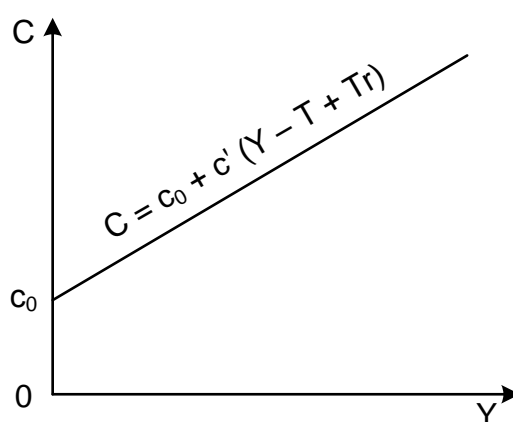

Fig. 7.3. The function graph of consumption

The vertical axis on the graph shows the changes in consumption, the horizontal axis shows the changes in income. The consumption line does not pass through the coordinate origin, it crosses the vertical axis at the level of autonomous consumption (point  $(C_0, 0)$ ).

*Autonomous consumption* means that a certain part of real consumer spending is in no way connected with the level of current income. Even in the absence of income ( $Y = 0$ ), the household cannot do without consumption. Consumption dependent on the current income is called induced consumption.

As the graph shows, the consumption curve has a positive slope, since there is a positive relationship between income and consumption. The slope of the consumption line is determined by the marginal propensity to consume  $c'$ .



## 7.2. The Keynesian model of consumer behaviour

Consumer spending of population is one of the main components of GDP and, consequently, a factor on which the state of the national economy depends to a certain extent. Therefore, the question of what influences the decision making of households to determine their consumption expenditures is an important macroeconomic problem.

Modern macroeconomic tools to research households, in particular, their functions such as consumption and saving are considered in the works of I. Fisher, J. M. Keynes, J. Duzenbury, M. Friedman, F. Modigliani, A. Ando, R. Brumberg and others. Moreover, each of them paid attention to different factors that affect household spending.

So, *I. Fisher* believed that consumption does not only depend on the current income, but is also determined by what incomes consumers expect to receive throughout their lives, as economic entities can borrow or save money. Moreover, each specific choice of consumers will be associated with the level of interest rates. If it increases, current consumption will decrease, and savings will increase.

The well-known *hypothesis of the life cycle of F. Modigliani* is based on *I. Fisher's* theory: throughout life, people save more when their incomes are above average, and spend more on consumption when their incomes are below average.

In *the hypothesis of M. Friedman's constant (permanent) income*, consumption does not depend on the current income, but on the constant one. Permanent income is the income that a person is able to maintain throughout his life at the expense of the labour income and the accumulation of assets.

Representatives of *institutionalism* in the analysis of household behaviour primarily take into account their internal structure, social norms, values, stereotypes, habits, uncertainty, scale and complexity of information, etc.

According to *the classical theory*, the factor determining the dynamics of savings and investments is the interest rate. If it grows, households begin to save more and consume less from each additional unit of income. The growth of household savings over time leads to a decrease in the price of credit that ensures the growth of investments.

According to *Keynesian theory*, it is not the interest rate, but the current distributed household income that is the factor that determines the dynamics of consumption. In the event of its growth, households are ready to spend more on consumer goods and services in each current period.

In *Keynesian theory*, the indicators of average and marginal propensity to consume are important.

*Average propensity to consume* (APC) is the share of disposable income that households spend on consumer goods and services:

$$APC = \frac{C}{Y_d}, \quad (7.5)$$

where APC is the average propensity to consume;

C is consumer spending;

$Y_d$  is personal disposable household income.

*Marginal propensity to consume* (MPC) is the proportion of the increase in spending on consumer goods and services in any change in disposable income:

$$MPC = c' = \frac{\Delta C}{\Delta Y_d}, \quad (7.6)$$

where MPC, or  $c'$  is the marginal propensity to consume;

$\Delta C$  is the increase in consumer spending;

$\Delta Y_d$  is the increase in disposable income.

Keynes believed that all the factors that affect MRS are realized through *the basic psychological law*, the essence of which is as follows: "People tend to increase their consumption with increasing income, but more slowly than income increases". Or: As income increases and wealth rises, the propensity of people to consume decreases.

This means that in the case of the increase in income per unit, consumption increases less than per unit, i.e.  $\Delta C < \Delta Y$ . The rest of the increase in household income is directed to an increase in savings:

$$\Delta S = \Delta Y_d - \Delta C, \quad (7.7)$$

where  $\Delta S$  is the increase in savings;

$\Delta Y_d$  is the increase in disposable income;

$\Delta C$  is the increase in consumption.

Graphically, the operation of Keynes's basic psychological law is presented in Fig. 7.4.

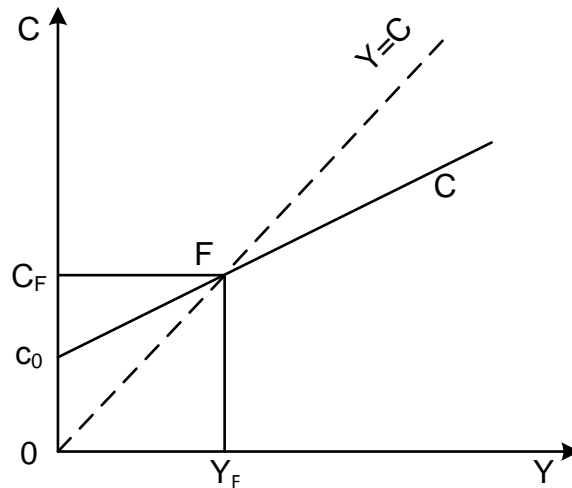

Fig. 7.4. **The Keynesian cross**

The vertical axis on the graph shows changes in consumption, the horizontal axis shows changes in income. The bisector of the angle between the axes determines the hypothetical line of equality of income and consumption  $Y = C$ , when all income is spent on consumption. The consumption line crosses the line  $Y = C$  at the point  $F$ , that is, with income  $Y_F$  and consumption  $C_F$  all income is spent on consumption. For any income greater than  $Y_F$ , not all income is consumed; some of it is saved. This model is called the Keynesian cross.

Marginal propensity to save (MPS) is the share of savings growth in any change in disposable income. MPS is the flip side of MPC:

$$\text{MPS} = s' = \frac{\Delta S}{\Delta Y_d} \quad (7.8)$$

where MPS, or  $s'$  is the marginal propensity to save;

$\Delta S$  is the increase in savings;

$\Delta Y_d$  is the increase in disposable income.

The sum of the marginal propensity to consume (MPC) and the marginal propensity to save (MPS) is equal to one, since they are two opposite parts in the change (increase or decrease) in income:

$$\text{MPC} + \text{MPS} = 1. \quad (7.9)$$

If  $MPC = 0$ , then the whole income is saved. If  $MPC = 0.5$ , it is an ideal situation for the economy, when an additional unit of income is equally spent on consumption and savings ( $MPC = MPS$ ), since consumption forms aggregate demand, and savings are the basis for investment, which, in turn, stimulates aggregate supply. If  $MPC = 1$ , the entire increase in income will be spent on consumption.

Most economists believe that for the economy as a whole,  $MPC$  and  $MPS$  are relatively constant values, provided that the government does not take special measures to change them.

## Glossary

**Marginal propensity to consume (MPC)** is the proportion of the increase in spending on consumer goods and services in any change in disposable income:

**Wealth effect (or real-balance effect)** means that change in the price level in a country leads to change in the real value of the wealth of a nation.

**Interest rate effect** means that when the price level in the country goes up, the purchasing power of the national currency decreases and accordingly the interest rate falls.

**Differentiation of income** (from the Latin *differentia* – difference) is the difference in the level of cash income of different layers and groups of the population.

**Foreign price effect** means that when the price level in the country goes up, consumer demand for foreign goods and services in that country increases because they become cheaper compared with domestic products.

**Demand shocks** are surprise events that lead to an increased or decreased demand for the output.

**Aggregate demand** is the size of total spending of key macroeconomic agents (households, enterprises, the government and the rest of the world) on domestic goods and services at each price level.

**Aggregate supply (AS)** is the output produced and sold in a given period.

**Supply shocks** are surprise events that lead to a decreased supply of the output.

## Problems with examples of solutions

**Problem 1.** The following changes took place in the country's economy throughout the year (in billion UAH): at the beginning of the year, tax-free income of the population was 130, consumption amounted to 102.5. At the end of the year, tax-free income was 150, consumption made 110. Determine the marginal propensity to consume.

*Solution.* Find the marginal propensity to consume, which is determined by the formula:

$$MPC = \frac{\Delta C}{\Delta Y_d} \times 100\%,$$

wherefrom

$$MPC = \frac{110 - 102.5}{150 - 130} \times 100\% = 37.5\%, \text{ or } 0.375.$$

**Problem 2.** The average annual income per person for the entire period of life is 15,300 UAH, and the average annual unplanned income is 1,800 UAH. At the same time, part of the fixed income spent on consumption is 0.7. Find the magnitude of the person's consumption using the fixed income hypothesis.

*Solution.* According to the theory of the life cycle, the consumer completely spends the unplanned income while the current income is partly spent. Therefore:

$15,300 \times 0.7 = \text{UAH } 10,710$  is a part of the fixed income spent on consumption.

$10,710 + 1,800 = \text{UAH } 12,510$  is human consumption per year.

## Questions for self-assessment

1. What are the main characteristics of the household?
2. What is household consumption?

3. What are the main reasons affecting the differentiation of household income?
4. What is the difference between consumption and saving and what do they have in common?
5. Explain why consumption is usually not equal to income?
6. What is the main meaning of the Keynesian function of consumption?
7. List the main factors affecting consumption.
8. What is the interaction of consumption and savings in the Keynesian model?
9. What does the Lorenz curve show?
10. Where is the Gini coefficient used?

### **Review questions**

1. Define a household, indicate its main functions.
2. Describe household consumption.
3. How are household incomes generated? Define the difference between personal income and personal disposable income.
4. What are the factors that determine the dynamics of consumption? Explain their effect.
5. Analyze the differentiation of income in society, using the Lorenz curve.
6. Give and explain the formula for the consumption function.
7. Determine the difference between autonomous and inductive consumption. What did Keynes relate to the existence of autonomous consumption?
8. What consumption theories do you know? What is the difference?
9. Provide definitions of the average and marginal propensity to consume.
10. Explain what the slope of the consumption curve depends on.

### **Practical tasks**

1. Germany's tax-free income is €180 billion, autonomous consumption is €28 billion, and consumer spending is €186 billion. Determine the average propensity to consume.

2. In the framework of the private closed economy, income is 500 billion UAH, depreciation is 120 billion UAH, retained earnings are 30 billion UAH. Determine the personal disposable income.

3. Determine the increase in consumption according to the hypothesis of the life cycle under the conditions that the income increased by 30 billion UAH, property – by 8 billion UAH. Moreover, the marginal propensity to consume from current income is 0.7, and the marginal propensity to consume from property is 0.25.

4. The current disposable household income is 15,000 UAH per year, and property – 50 000 UAH. The marginal propensity to consume current income is 0.8, and property – 0.025. Autonomous consumption is equal to 1 000 UAH. Calculate household consumption according to the Keynesian consumption function and the life cycle hypothesis.

### **Heuristic tasks**

1. It is known that old people continue to save even after retirement. How can you explain this phenomenon from the point of view of the M. Friedman theory of constant income?

2. Comment on the following statement: "Increasing the marginal propensity to save increases the portion of the income that is spent on consumption".

3. Why, from the point of view of the theory of constant income of M. Friedman, gamblers allow themselves a fairly high level of consumption even in those years when they are not lucky?

### **Tests**

1. The marginal propensity to consume is:

- a) the ratio of total consumption to total income;
- b) a change in consumer spending caused by a change in income;
- c) the ratio of growth in consumer spending to a unit of growth in income;
- d) a curve that characterizes the amount of consumption.

2. According to Keynesian theory, the volume of consumer spending in a country depends, first of all, on:

- a) the place of residence of the consumer;
- b) the age of household members;
- c) the level of national income;
- d) the level of income that the household controls.

3. Formulated by J. Keynes, the basic psychological law of consumer behaviour is defined as follows:

a) with the growth of income, the consumer increases his consumption, but not to the same extent that income grows;

b) with an increase in income, a consumer increases his consumption to the same extent as income;

c) with an increase in income, the consumer buys more expensive goods;

d) in general, this law is not related to consumption.

4. In the Keynesian consumption function  $C = C_0 + s' Y_d$ :

a)  $C_0$  is autonomous consumption that characterizes the minimum level of consumption that people need;

b)  $c'$  is the marginal propensity to consume;

c)  $Y_d$  is disposable income;

d) all answers are correct.

5. The consumer spending has changed from 120 to 200 monetary units; the income has changed from 100 to 200 monetary units. Under these conditions, the marginal propensity to consume is:

a) 1.0;

b) 0.8;

c) 0.6;

d) 0.4.

6. Suppose that 100 families live in the country A. One half of the families have a marginal propensity to consume equal to  $1/2$ , and the second one to  $3/4$ . If the income that a family can dispose of increases by €10,000 and the entire increase in income falls with the first half of the families, then the total expenditure on consumption will increase by:

a) €5,000;

b) €2500;

c) €7,500;

d) expenditures on consumption will not increase.



7. The average propensity to consume is:

- a) a part of consumer spending, the dynamics and volume of which depend on income;
- b) a part of annual income that is directed to consumption expressed as a percentage;
- c) the curve that characterizes the value of consumer spending at a given level of income;
- d) the level of income that the family manages.

8. According to the classical theory, to stimulate an increase in savings, it is necessary:

- a) to reduce the taxes on income;
- b) to increase the interest rate;
- c) to increase the volume of assistance to children;
- d) to increase the premium for savings allocated for construction.

9. Which of the dependencies corresponds to the real process of economic life:

- a) high marginal tax rates on corporate income and personal income contribute to investment;
- b) in periods when high unemployment rates are observed, new jobs are not created;
- c) part of investments in GDP and the growth rate of labour productivity are inversely related;
- d) there is a close direct relationship between the part of GDP that is allocated for investment and the rate of growth of labour productivity?

10. The consumption function is determined by the formula  $C = 30 + 0.2 Y$ . The disposable income, compared with the previous year, decreased by 100 bln money units. How much has consumption decreased (bln money units):

- a) by 50;
- b) by 20;
- c) by an indefinite value;
- d) by 30?

Answers: 1c; 2d; 3a; 4b, c; 5b; 6a; 7b; 8b; 9d; 10b.

## 8. Private investment

Investment is one of the most important macroeconomic variables in international comparisons. To prove the significance of investment, it is enough to take a close look at the relationship between investment and nominal GDP: when investment in the country increases, nominal GDP also rises. For this reason, section 8 examines the essence, types and factors impacting on investment as well as the process of transition of saving into investment in the economy without government and international trade.

The focus is also on the approaches to the estimation of the profitability of investment projects. So an insight is provided into how the expected return of investment is calculated and how scientists and policymakers can use this data to assess the overall economy. This section also provides information about the investment multiplier effect and its interaction with a simple accelerator model in a closed private economy.

8.1. Saving and investment.

8.2. Capital investment.

8.3. The estimation of the profitability of investment projects.

**Key terms:** private closed economy, saving, saving schedule, marginal propensity to save, investment, capital goods, depreciation rate, autonomous investment, planned investment, induced investment, investment tax credit, neoclassical investment function, Keynesian investment function, investment demand curve, investment multiplier, investment accelerator, multiplier effect, investment project, expected rate of return, marginal product of capital.

### 8.1. Saving and investment

As discussed earlier in the textbook (section 7), disposable income consists of two parts: consumption and saving. It is mathematically described as:

$$Y_d = C + S, \quad (8.1)$$

$$\text{hence } S = Y_d - C, \quad (8.2)$$

where  $Y_d$  is disposable income;

$C$  is consumption;

$S$  is saving.

Saving is a part of disposable income that is not consumed now. The modern forms of saving are the following:

1) cash:

a) cash in national currency;

b) cash in foreign currency;

2) checking and non-checking accounts:

a) certificates of deposits (CDs);

b) money market accounts (MMAs);

c) "money market" mutual funds;

3) tangible assets:

a) real estate;

b) vehicles;

c) commodities such as precious metals (gold, silver, copper, tin, etc.), jewelry, oil, gas, artwork, old comic books;

4) intangible assets:

a) electronic money (or cryptocurrencies) that are digital assets created and enshrined in their underlying code;

b) licenses;

c) patents;

5) securities:

a) shares of stock;

b) bonds;

c) bills.

It is known that "money market" mutual funds, shares and bonds are the most important part of saving in the advanced nations such as North American, Austrian, British, Canadian, Japanese, South Korean, Swedish and others. For example, more than 100 million Americans save about 10 trillion dollars in the form of securities. In contrast to American experience, Ukrainian citizens prefer to save cash in U.S. dollars and euros, foreign currencies, that is fully logical in the conditions of economic, social and political instability. According to the VoxUkraine, a famous consulting agency, the total saving of Ukrainians varied between 22 and 86 bln U.S. dollars in 2016.

All forms of saving involve some degree of risk, so, to choose the right form of them, one should remember that their saving must correspond to the following requirements:

liquidity that is an ability of savings to turn easily and quickly into money;

safety that is a probability that the deposited funds return back;  
income rate that is an ability of savings to give additional income.

There are some factors impacting on saving in the private closed economy. Obviously, disposable income is a crucial determinant of the saving dynamics. The positive relationship between saving and disposable income is described as:

$$S = s_0 + s' \cdot (Y - T + TR), \quad (8.3)$$

$$\text{or } S = s_0 + s' \cdot Y_d, \quad (8.4)$$

where  $S$  is saving;

$s_0$  is autonomous saving;

$s'$  is marginal propensity to save;

$Y$  is income;

$T$  is personal taxes;

$TR$  is transfers.

To test the function above, suppose that disposable income ( $Y_d$ ) in the country A is 225 bln lire and the saving function is described as:  $S = 120 + 0.15 \cdot Y_d$ . To calculate the size of saving in this economy, put the initial data in the function above and obtain:  $S = 120 + 0.15 \cdot Y_d = 120 + 0.15 \cdot 225 \text{ bln lire} = 33.75 \text{ bln lire}$ . In this simple example the size of saving is 33.75 bln lire.

The relationship between saving and disposable income can also be shown graphically (Fig. 8.1).

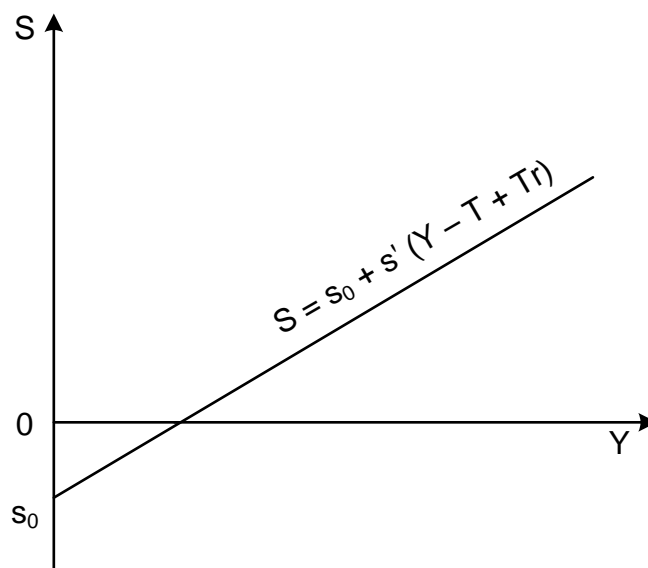

Fig. 8.1. The saving curve

The graph above demonstrates that the saving curve does not cross the origin; it just crosses the vertical axis (S) on the level of autonomous saving ( $s_0$ ). It is significant that the saving curve has a positive inclination and the slope of a saving curve is determined by marginal propensity to save (MPS). Marginal propensity to save shows what amount of additional disposable income households save and it is calculated as:

$$MPS = \frac{\Delta S}{\Delta Y_d}, \quad (8.5)$$

where MPS (or s') is marginal propensity to save;

$\Delta S$  is a change in saving;

$\Delta Y_d$  is a change in disposable income.

By similar reasoning, average propensity to save is the ratio between the size of saving and disposable income. To express this point mathematically, write:

$$APS = \frac{S}{Y_d}, \quad (8.6)$$

where APS is average propensity to save;

S is saving;

$Y_d$  is disposable income.

In the private closed economy, the sum of average propensity to save (APS) and average propensity to consume (APC) always equals 1 and the sum of marginal propensity to save (MPS) and marginal propensity to consume (MPC) also equals 1. For example, if marginal propensity to consume in the country A is 0.83, then marginal propensity to save will equal 0.17 ( $MPS = 1 - MPC = 1 - 0.83 = 0.17$ ).

Keep in mind that we consider the essence, structure and role of saving in the private closed economy that has only two macroeconomic agents: aggregate consumer and aggregate producer. On that note, GDP can be calculated as:

$$Y = C + I. \quad (8.7)$$

At the macroeconomic level, households' income is described as:

$$Y = C + S. \quad (8.8)$$

Summarizing the above, we can conclude that in the private closed economy, saving must be equal to investment. So the main condition for achieving a general equilibrium is the following:

$$S = I. \quad (8.9)$$

Suppose that autonomous investment in the country Z is 185 bln euros and the saving function is described as:  $S = -50 + 0.2 \cdot Y_d$ . To calculate the equilibrium disposable income, use equation (8.9). Equating saving function and the size of autonomous investment, obtain:

$$\begin{aligned} -50 + 0.2 \cdot Y_d &= 185 \text{ bln euros,} \\ 0.2 \cdot Y_d &= 205 \text{ bln euros,} \\ Y_d &= 1025 \text{ bln euros.} \end{aligned}$$

So in equilibrium, disposable income in the country Z is 1025 bln euros.

There are two views on the equilibrium between saving and investment in the private closed economy. In the view of neoclassical economists, the real interest rate equilibrates saving and investment (Fig. 8.2).

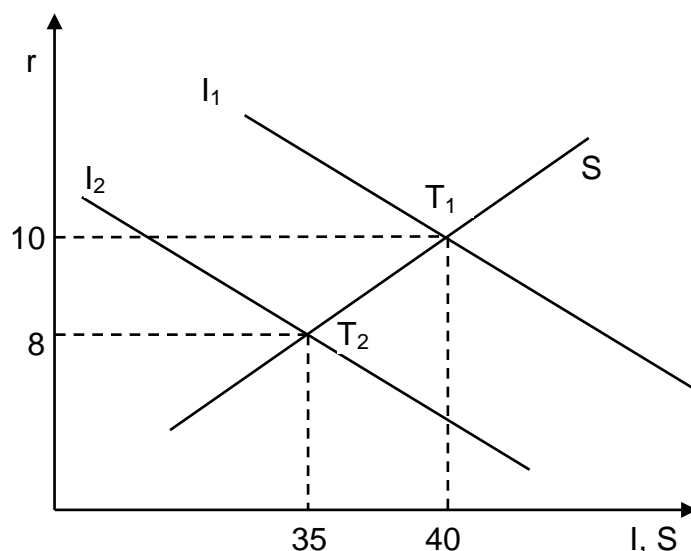

**Fig. 8.2. The neoclassical view on the equilibrium between saving and investment**

As Fig. 8.2 clearly shows, a decline in investment (from  $I_1$  to  $I_2$ ) leads to the decrease in real interest rate (from 10 to 8 %) and results in the decline in saving (from 40 to 35 bln euros). On the other hand, an increase in saving (from 35 to 40 bln euros) leads to the increase in the real interest rate (from 8 to 10 %) and results in the increase in consumption that recovers full employment in the closed private economy.

In contrast, Keynesian followers examined the equilibrium between saving and investment based on the hypothesis that investment is not flexible, so the investment demand curve slopes downward. These economists (J. Keynes, E. Domar, R. Harrod) pointed out that output and disposable income are the key factors equilibrating saving and investment. Another important point of Keynesian theory is that saving is unelastic so the saving curve is vertical (Fig. 8.3).

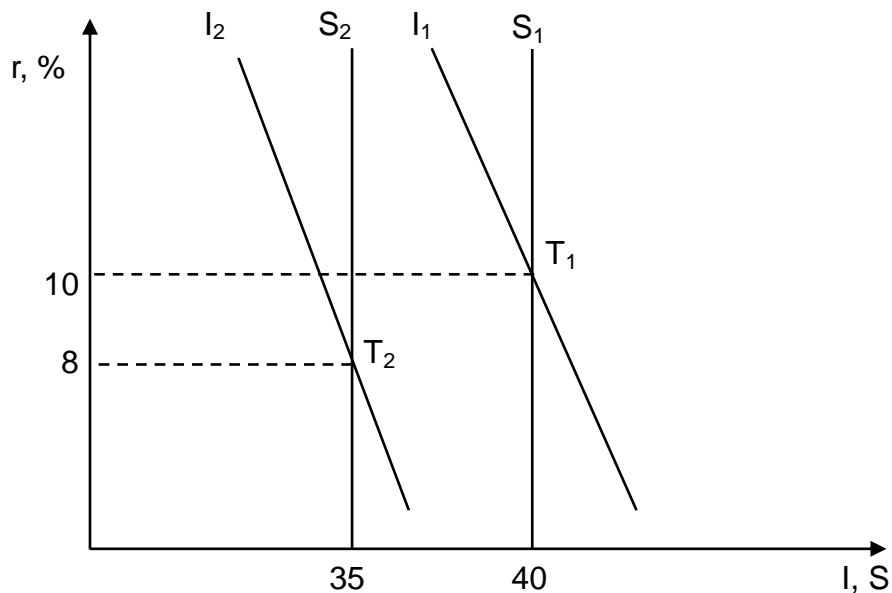

**Fig. 8.3. The Keynesian view on the equilibrium between saving and investment**

Suppose, for example, that investment in a country A is 40 bln euros in the full employment (it is the point  $I_1$  in Fig. 8.3). Pessimistic business expectations about political climate and human productivity resulted in the decrease in investment by 5 bln euros (from  $I_1$  to  $I_2$ ) and the decrease in the real interest rate by 2 % (from 10 to 8 %). As investment is unelastic, in the Keynesian view, then it is 40 bln euros and does not change. Thereby, from this view point, equilibrium between saving and investment can be reached even in the conditions of full employment.

## 8.2. Capital investment

In a general sense, investment is a flow of costs aiming to provide additional income (usually in the form of profit, interest, dividends or rents); the goal of any investor is to make money. In macroeconomics, an investment is the purchase of durable goods by households and enterprises that are not consumed today but are used in the future to satisfy their needs and create wealth. In finance, an investment is a financial asset purchased with the idea that it will produce income in the future or will later be sold at a higher price for a profit. One should differentiate investment from capital: investment is a flow while capital is a stock.

Speaking about the main types of investment in Keynesian macroeconomic models, one should list the following:

1) capital investment such as buildings, production facilities, capital equipment, plants, machinery, machines, engines, inventories, railroad, automobiles, buses, etc.;

2) investment in house construction, in particular construction and purchasing of new house buildings;

3) investment in stocks, namely investment in final goods, unfinished production and construction;

4) gross investment that is the value of all investment goods, including the value of depreciation;

5) net investment that is the value of investment goods, excluding the value of depreciation;

6) autonomous investment that is not related to the real interest rate;

7) induced investment that is injections caused by the increase in the real GDP;

8) planned (or expected) investment;

9) unplanned investment that is mainly unexpected investment in stocks;

10) actual investment that is the sum of planned and unplanned investment.

In a modern business world, there are some modern types of investment. These are the following:

1) state investment induced by government;

2) private investment induced by all legal forms of businesses such as sole proprietorship, partnership and corporation and individuals;



- 3) real investment aiming to produce new goods and services;
- 4) direct (or capital) investment that is mainly investment in fixed capital;
- 5) financial investment that is investment in securities;
- 6) foreign investment that is investment of non-residents of the country.

### Interesting to know

Consider the dynamics of foreign direct investment in Ukraine in 2014 – 2018 (Table 8.1) [202].

Table 8.1

#### The dynamics of foreign direct investment in the Ukrainian economy

Indicator	2014	2015	2016	2017
Total foreign direct investment, bln dollars	40.7	36.15	37.5	39.14
Including:				
foreign direct investment from Ciprus, bln dollars	12.77	10.23	9.69	10.00
foreign direct investment from the Netherlands, bln dollars	6.99	6.18	5,9	6,29
foreign direct investment from Germany, bln dollars	2.1	1.6	1.58	1.79
foreign direct investment the Virgin Islands, bln dollars	1.99	1.72	1.68	1.6
foreign direct investment from Great Britain, bln dollars	2.15	1.79	2.00	2.17

As Table 8.1 shows, the size of foreign direct investment in Ukraine varies from 36.15 to 40.7 bln dollars. These figures are insignificant and are caused by unstable economic situation in the country, namely rapid devaluation of the hryvnia, the national Ukrainian currency, revival of inflation processes, rising of cyclical unemployment and, as a result, a dramatic decline in the investment attractiveness of the country. Key investors in the Ukrainian economy are so-called "offshore zones", namely Cyprus and the Virgin Islands. In particular, the size of direct foreign investment from Cyprus into Ukraine equalled almost 25 % of the total foreign investment in 2017. Besides, Dutch and German businesses invest quite a lot of money into the Ukrainian economy, although these processes tend to slow down. For example, the size of foreign direct investment from Germany decreased by 17.3 % (or 0.31 bln dollars) during the same period. Similarly, the size of foreign direct investment from the Netherlands decreased by 10 % (or 0.7 bln dollars) in 2014 – 2017.

Both enterprises and households buy capital goods. Enterprises purchase capital goods aiming to add their stock of capital or to replace the existing facilities and equipment. Households buy durable goods such as refrigerators, TV sets, computers, mincing machines, etc., that are also part of investment spending. According to the State Statistics Committee of Ukraine, total investment spending in Ukraine in 2017 equalled 18 percent of nominal GDP. In contrast, according to the FED, total investment spending in the United States in the same period reached 17 percent of nominal GDP.

From Keynesian viewpoint, the real interest rate is the key factor impacting on the investment dynamics. The relationship between the real interest rate and investment can be described as:

$$I = I_a - d \cdot r, \quad (8.10)$$

$$I_a = \gamma \cdot (Y_2 - Y_1), \quad (8.11)$$

where  $I$  is the size of investment;

$I_a$  is autonomous investment;

$d$  is marginal propensity to invest (or investment accelerator);

$r$  is real interest rate;

$\gamma$  is capital intensity of goods;

$Y_1$  is the initial GDP;

$Y_2$  is the final GDP.

$\gamma$  is an empirical coefficient of investment sensibility to the real interest rate.

Accordingly, a change in the size of investment is calculated as:

$$\Delta I = \Delta I_a - d \cdot \Delta r. \quad (8.12)$$

On the other hand, new classical economists noted that investment demand is determined by the difference between the expected and actual capital investment. These economists describe the investment function as:

$$K^f = f(MCC, Y^e), \quad (8.13)$$

$$MCC = r + d + (n \cdot t), \quad (8.14)$$

where  $K^f$  is the expected size of capital investment;

$f$  is the function;

$MCC$  is marginal capital costs;

$Y^e$  is the expected GDP;

$d$  is depreciation;

$(n \cdot t)$  is net marginal taxes.

The relationship between the real interest rate and investment can be presented graphically (Fig. 8.4).

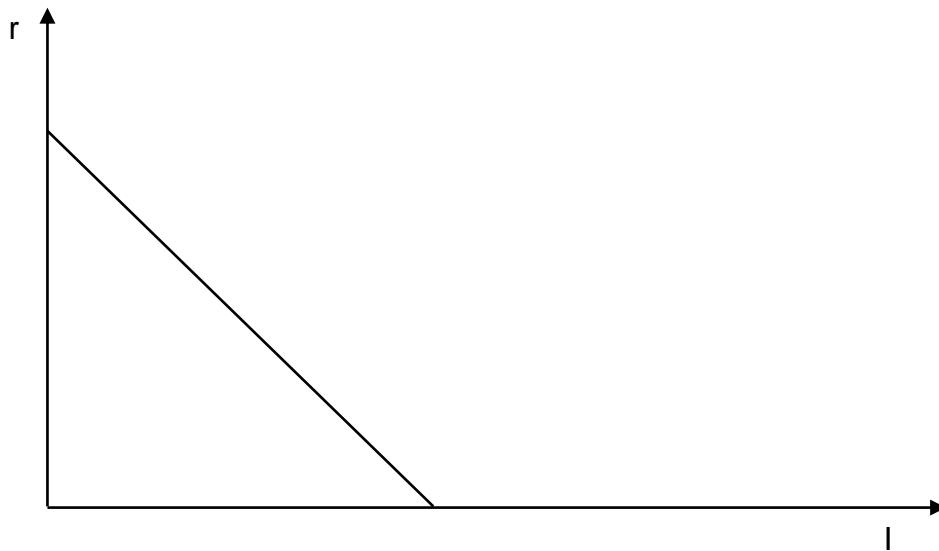

Fig. 8.4. **The investment demand curve**

Fig. 8.4 shows that the investment demand curve slopes downward, which means that the relationship between the real interest rate and investment is inverse. If the real interest rate rises, the size of investment declines; if the real interest rate decreases, the size of investment increases.

There are several non-interest-rate determinants shifting the investment demand curve (Fig. 8.5).

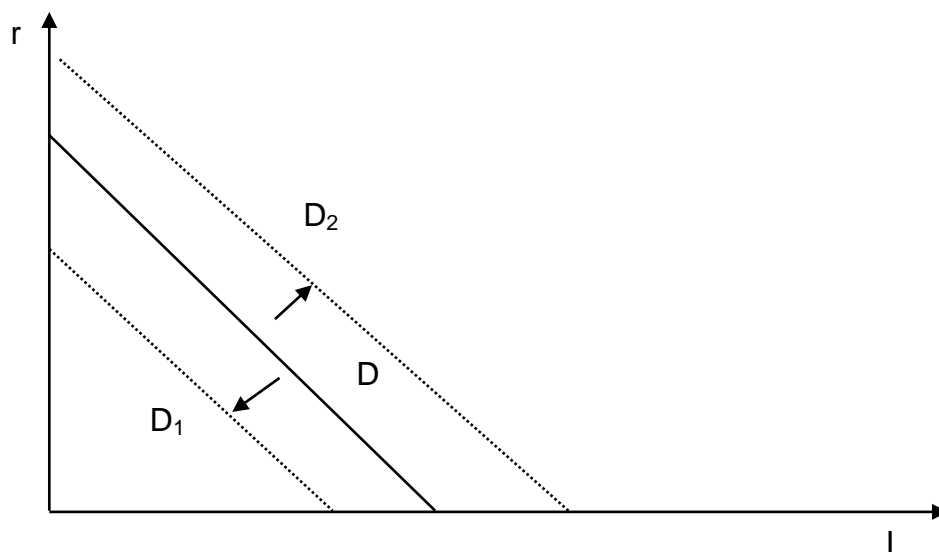

Fig. 8.5. **Shifting of the investment demand curve**

The costs of investment goods is the first determinant shifting the investment demand curve. If the costs of acquiring, operating or maintaining capital goods decrease, investment also decreases and the investment demand curve shifts rightward (from  $D$  to  $D_2$ ); if the costs increase, investment increases and the investment demand curve shifts leftward (from  $D$  to  $D_1$ ). For instance, an increase in the wages minimum in Ukraine in 2018 led to the increase in labor costs and accordingly a shift in the investment demand curve leftward.

Business taxes and fees is another non-interest-rate determinant affecting the investment dynamics and shifting the investment demand curve. If business taxes such as the corporate profit tax and the excise tax on goods increase, investment decreases and the investment demand curve shifts leftward; if business taxes or fees decrease, investment increases and the investment demand curve shifts rightward. Similarly, a decrease in the value-added tax in Ukraine in 2017 stimulated domestic investment and, in that way, shifted the investment demand curve rightward.

Technological advance is also a very important factor affecting investment in the real economy. Technological innovation, the development of new goods, improvement of existing goods, creation of new equipment reduce the costs of operating and maintaining capital goods and increase the profitability of investment projects. In short, technological change always shifts the investment demand curve rightward.

Business expectations of future costs and future profitability of investment projects influence firms' investment spending too. As a rule, an optimistic outlook on the future domestic political climate, tax legislation, population growth leads to the increase in the investment demand and shifts the investment demand curve rightward; a pessimistic outlook on future changes results in the decrease in investment spending and shifts the investment demand curve leftward. Here is a picture proving the statement above: Russia's annexation of Crimea in 2014 and the war conflict in the east of Ukraine resulted in a considerable decrease in investment spending (from 249.87 bln UAH in 2013 to 219.42 bln UAH in 2014) and shifted the investment demand curve leftward. It was a real threat to modern Ukrainian society.

Besides, the stock of durable goods on hand also influences the investment dynamics. Without going into detail, note the following: if the economy of the country is overstocked with capital goods, the firms'

incentives to invest decline and the investment demand does not arise; if the economy of the country is understocked with capital goods, the enterprises aim to sell their final goods as fast as they can, so firms' incentives to invest increase.

Investment plays a great role in today's rapidly changing world: more investment spending usually results in a larger real GDP. In the economic world, this is called the investment multiplier effect that was proposed by R. Kahn in 1931 and explained by J. Keynes in his fundamental work "The General Theory of Employment, Interest Rate and Money" in 1936. It states that an initial change in investment positively impacts on real GDP. The investment multiplier is calculated as:

$$m_i = \frac{\Delta Y}{\Delta I} = \frac{1}{MPS} = \frac{1}{1-MPC}, \quad (8.15)$$

where  $m_i$  is the investment multiplier;

$\Delta I$  is a change in investment;

$\Delta Y$  is a change in GDP.

In addition to the analysis of the relationship between investment and real GDP, it is useful to examine the investment accelerator that was proposed by A. Aftalion and J. Clark in the 1910s of the 20th century. The investment accelerator is calculated as:

$$a_i = \frac{\Delta Y}{\Delta I}, \quad (8.16)$$

where  $a_i$  is the investment accelerator.

To understand the investment accelerator effect, consider the following example (Table 8.2). Suppose that the stock of capital is 500 mln lire and it provides the production of goods and services estimated at 100 mln lire. In other words, the ratio between the capital and the output is 5 : 1. The term of the capital use is 10 years, so the value of depreciation is 50 mln lire (Value of depreciation =  $\frac{500 \text{ mln lire}}{10 \text{ years}} = 50 \text{ mln lire}$ ) each year. Make clear

how changes in aggregate demand impact on changes in investment demand.

Table 8.2

### A simple accelerator model

Indicator	Year 1	Year 2	Year 3	Year 4	Year 5	Year 6
Aggregate demand, mln lire	100	105	115	120	122	120
Stocks of capital, mln lire	500	525	575	600	610	600
Demand for new capital, mln lire	–	25	50	25	10	-10
Value of depreciation, mln lire	50	50	50	50	50	50
Investment demand, mln lire	50	75	100	75	60	40

Table 8.2 reveals three conformities to natural laws. Firstly, an increase in aggregate demand results in a larger change in investment demand. For instance, aggregate demand increased by 5 mln lire (from 100 to 105 mln lire) in year 2; investment demand increased by 25 mln lire (from 50 to 75 mln lire) during the same period. Secondly, a simple slowing down in the increase in aggregate demand resulted in a decrease in investment demand by 25 mln lire (from 100 to 75 mln lire) in year 4 and by 15 mln lire (from 75 to 60 mln lire) in year 5. Thirdly, the decrease in aggregate demand resulted in a decrease in investment demand by the size less than the value of depreciation (year 6).

Now let's calculate the investment multiplier and the investment accelerator in Ukraine during 2011 – 2017 using formulas (8.15 – 8.16). The obtained results are presented in Table 8.3.

Table 8.3

### Calculation of the investment multiplier and investment accelerator in Ukraine

Indicators	Years						
	2011	2012	2013	2014	2015	2016	2017
1	2	3	4	5	6	7	8
Real GDP at the beginning of the year, bln UAH	1 082.57	1 302.08	1 400.49	1 413.13	1 397.56	1 333.03	1 737.98

Table 8.3 (the end)

1	2	3	4	5	6	7	8
Real GDP at the end of the year, bln UAH	1 302.08	1 400.49	1 413.13	1 397.56	1 333.03	1 737.98	1 985.86
Capital investment at the beginning of the year, bln UAH	189.06	359.22	259.93	293.69	267.73	219.42	273.12
Capital investment at the end of the year, bln UAH	259.93	448.46	293.69	267.73	219.42	273.12	359.22
Investment multiplier	4.00	1.1	0.37	0.6	1.34	7.54	2.88
Investment accelerator	0.25	0.9	2.7	1.67	0.75	0.13	0.35

Let's explain our calculations. The investment multiplier in the Ukrainian economy in 2017 has been calculated as follows:

$$m_i = \frac{1985.86 \text{ bln UAH} - 1737.98 \text{ bln UAH}}{359.22 \text{ bln UAH} - 273.12 \text{ bln UAH}} = 2.88.$$

Accordingly, the investment accelerator in the Ukrainian economy in 2017 has been calculated as:

$$a_i = \frac{1}{2.88} = 0.35.$$

Table 8.3 shows that both the investment multiplier and investment accelerator in the country were not steady. In particular, the investment multiplier changed from 0.37 in 2013 to 7.54 in 2016. Consequently, the investment accelerator also varied from 2.7 in 2013 to 0.13 in 2016.

In practice, investment spending seems to be unstable. Durability of capital goods, irregularity of technical advance are two key causes of the volatility of investment today. Fig. 8.6 shows how volatile gross investment and nominal GDP in Ukraine changed during 1997 – 2017. Annual percentage changes in gross investment are larger than the percentage changes in nominal GDP in Ukraine in that period.

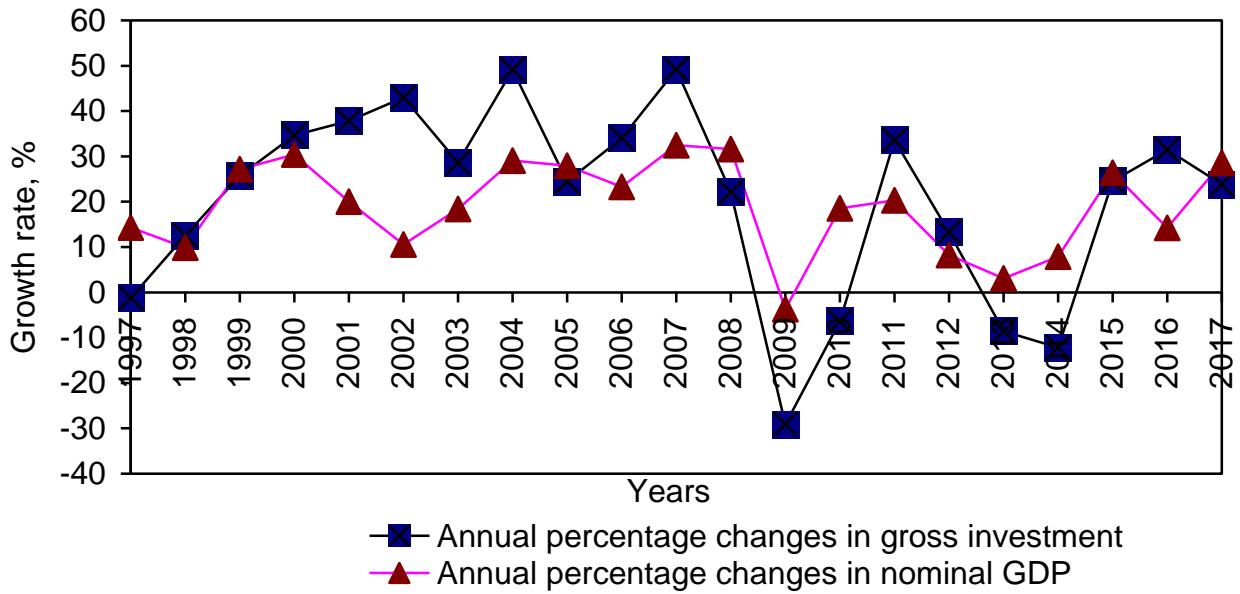

**Fig. 8.6. The changes of nominal GDP and gross investment in Ukraine**

The relationship between the investment and nominal GDP is characterized by different level of elasticity (Fig. 8.7).

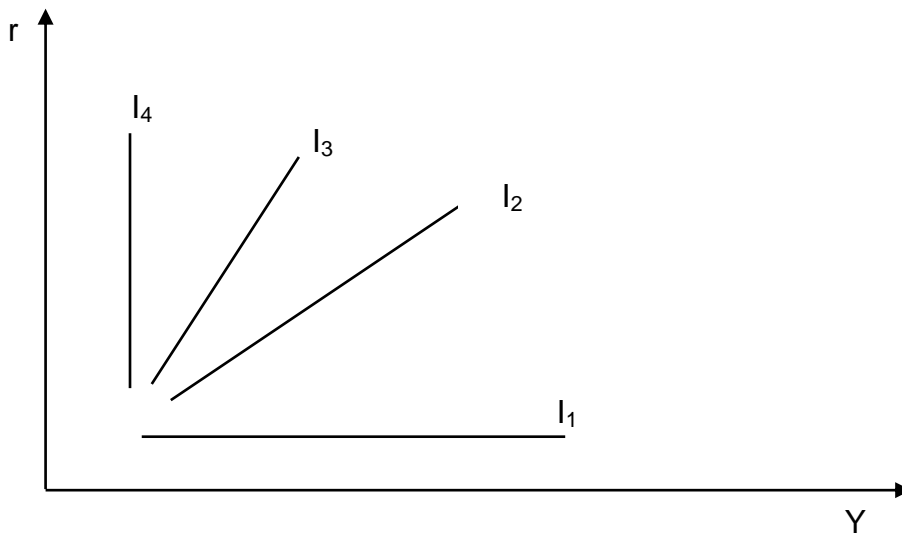

**Fig. 8.7. The graphical interpretation of the relationship between the investment and nominal GDP**

As Fig. 8.7 shows, line  $I_1$  is horizontal, which means that the relationship between the investment and nominal GDP is perfectly elastic: the investment is used effectively and the same size of investment provides a constant increase in nominal GDP. Line  $I_4$  is vertical, which means that the relationship between



the investment and nominal GDP is perfectly inelastic that is explained by full employment in the economy without government and international trade. Indeed, the investment curve must slope upward. Line  $I_2$  proves that in order to increase GDP it is needed to accumulate capital and implement technological innovations. Keep in mind: when the effectiveness of capital use increases, the slope of investment rises. Line  $I_3$  tells us about the ineffective use of capital: more investment spending results in a smaller nominal GDP. It provides the theoretical basis for balancing the macroeconomic policy.

From this perspective, one should also take into account the indicators characterizing the effectiveness of private investment. First of all, it is marginal product of capital that, holding other macroeconomic variables constant, shows a change in additional capital and is calculated as:

$$MPC = f(C + 1, L) - f(C, L), \quad (8.17)$$

where MPC is the marginal product of capital;

$f$  is the function;

$f(C + 1, L)$  is the nominal GDP produced by capital  $(C + 1)$  and labor  $(L)$ ;

$f(C, L)$  is the nominal GDP produced by capital  $(C)$  and labor  $(L)$ .

The relationship between the marginal product of capital and nominal GDP is shown in Fig. 8.8.

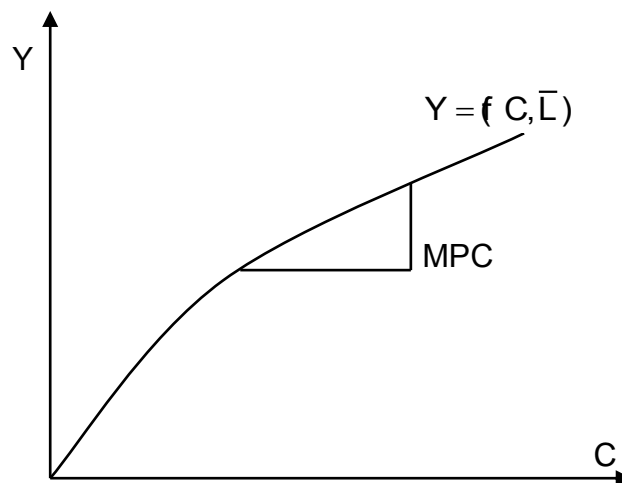

**Fig. 8.8. The relationship between the marginal product of capital and gross domestic product**

The graph demonstrates the phenomenon of the diminishing marginal product of capital: when the size of capital in the economy increases, the marginal product of capital decreases.

Another important indicator characterizing the effectiveness of gross investment is the marginal revenue of capital. It shows how the potential GDP changes when the size of capital rises by 1 % and is calculated as:

$$\Delta Y_p = \Delta C \cdot \text{MRC}, \quad (8.18)$$

where  $\Delta Y_p$  is a change in potential GDP;

$\Delta Y_p$  is a change in capital;

MRC is the marginal revenue of capital.

### 8.3. The estimation of the profitability of investment projects

There are two major approaches to the estimation of profitability of investment projects: the accounting and net present value approaches.

The accounting (or traditional) approach to the estimation of profitability of investment projects is based on the determination of the net profit rate. The net profit rate is the ratio between the net profit from the investment project and the total investment in the project that can be written as:

$$\text{NPI} = \frac{\text{NP}}{I} \cdot 100, \quad (8.19)$$

where NPI is the net profit rate;

NP is the net profit;

I is investment.

Apply the accounting method to the estimation of profitability of investment projects. Suppose that you have five possibilities to make money investing in one of the following projects (Table 8.4).

Table 8.4

#### The relationship between the investment and the expected rate of return

Indicators	Project 1	Project 2	Project 3	Project 4	Project 5
Investment, mln pesos	20	20	20	20	20
Net profit, mln pesos	5	3.5	4	2.8	1.5

To choose the right project to invest money, calculate the net profit rate of each project using formula (8.19) and obtain:

$$\text{NPI}(1) = \frac{5 \text{ mln pesos}}{20 \text{ mln pesos}} \cdot 100 = 25.$$

$$\text{NPI}(2) = \frac{3.5 \text{ mln pesos}}{20 \text{ mln pesos}} \cdot 100 = 17.5.$$

$$\text{NPI}(3) = \frac{4 \text{ mln pesos}}{20 \text{ mln pesos}} \cdot 100 = 20.$$

$$\text{NPI}(4) = \frac{2.8 \text{ mln pesos}}{20 \text{ mln pesos}} \cdot 100 = 14.$$

$$\text{NPI}(5) = \frac{1.5 \text{ mln pesos}}{20 \text{ mln pesos}} \cdot 100 = 7.5.$$

Therefore, you probably choose the first investment project because it is the most profitable one (NPI is 25 %).

Now it is time to mention the most attractive sectors in terms of the net profit rate throughout the world. According to e-commerce services, oil and gas extraction, equipment rental and leasing are the most capacious industries in developed countries. Unlike most advanced economies, the most attractive and profitable sectors in Ukraine are agriculture, wires, rails, software, hardware, pharmaceutical and health industries as well as housing rental.

### **Interesting to know**

#### **How to identify the most profitable investment projects in the Ukrainian housing market?**

Based on the statement that housing rental and hosting are profitable business activities in the Ukrainian economy, it is useful to learn how to identify the most profitable investment projects in the national housing market.

The most important thing is location because developed infrastructure and places where people can buy things in case of emergency as well as low crime rate attract potential tenants and allow real estate investors to charge a high rent. If you are planning to invest in the housing market, you should make other proprietors' acquaintance to determine the real rent on houses in your location.

(to be continued)

(continued from p. 155)

Another important thing to take into consideration is an appreciation of rental property that is the increase in the house's value over time. Undoubtedly you should choose the houses and flats which tend to increase in value in the future because it will help you to make money by selling them at a price much higher than the initial purchase price.

You must also bear in mind the positive cash flow and determine the difference between the future rental income and the costs of rental property. In order to do this, you should conduct a real estate market research, calculate all types of costs such as costs of operating and maintaining a house (or a flat), property taxes, rental property taxes, property management fees, water and electricity bills as well as repairs before buying the rental property. In addition, after making a purchase, you as a housing investor need to plan your finances accurately and spend wisely to ensure that the investment property will generate and maintain a positive cash flow.

To estimate the profitability of your investment project, you have to calculate two indicators: capitalization rate and cash on cash return. Use the following formulas:

$$R_c = \frac{NOI}{CMV} \cdot 100, \quad (8.20)$$

$$CCR = \frac{NOI_A}{I_T} \cdot 100, \quad (8.21)$$

where  $R_c$  is capitalization rate;

$NOI$  is net operating income from rental property;

$CCR$  is cash on cash return;

$CMV$  is current market value of rental property;

$NOI_A$  is net operating income from rental property per year;

$I_T$  is total investment in rental property.

Remember you can be sure that your rental property is profitable if both capitalization rate and cash on cash return are not lower than 15 %.

The profitability of investment projects usually varies from 15 to 50 % but there are some businesses that allow their runners to charge excess incomes. According to the Forbes, investment in online activities such as blogging, web designing, online tutoring, online grocery shops, managing social media accounts or YouTube channels charge incomes more than 100 % per year. For example, Pewdiepie, the most famous YouTuber, earned about 12 mln dollars in 2017 and its net profit rate reached 125 % in the same period. In short, taking into account that investment projects charge profits for several years, the average annual net profit and average annual cost of capital must also be key indicators used to estimate the profitability of an

investment project. For that reason, the entrepreneurs make investment decisions by comparing the net profit rate and the net interest rate.

### Interesting to know

#### How does China fund its large infrastructure projects?

As we know, China's natural resources are mainly nationalized. For example, the National Oil Company (NOC) is the famous oil company fully owned by the Chinese government. According to the World Bank's analytics, the company accounted for almost 75 % global oil production and controlled more than 85 % of the proven oil reserves in 2010 – 2015. NOC's oil profits go into the most profitable infrastructure projects aiming to develop human capital and build nation.

Chinese government also run profitable businesses that require large-scale development to create global markets, like inorganic chemicals or rubber manufacturing. The profits from these activities invest into projects that only a large central government can underwrite. The most profitable projects are the following: China's impressive space program (CISP) and the construction of the New Silk Road Eurasian Freight Train System (NSREFTS) stretching across Eurasia from Eastern China, and across the Russian Federation, Germany, and France all the way to Spain.

It's a no-brainer that the main demerit of the accounting method for the estimation of profitability of investment projects is that it does not take into account the period of time. Because the investment process is always related to risks, the longer investment projects suggest a longer payback period and higher risks.

In macroeconomics, there is also another important approach to the estimation of profitability of investment projects that is called the net present value approach. It is based on the calculation of the net present value that is the difference between the net value of the expected profit and the net value of the expected costs. In other words, it expresses the value of future payment flows in the value of current payment flows. The net present value is calculated as:

$$NPV = \sum_{t=1}^{t=n} \frac{Q_t - C_t}{(1+r)^t}, \quad (8.22)$$

where NPV is the net present value;

$Q_t$  is the income in the period  $t$ ;

$C_t$  is the costs in the period  $t$ ;  
 $r$  is the real interest rate.

If the net present value is positive ( $NPV > 0$ ), the investment project is probably profitable. If the net present value is negative ( $NPV < 0$ ) or equals 0 ( $NPV = 0$ ), the investment project is unprofitable and should be discarded. On the other hand, when the real interest rate decreases, the net present value and the marginal propensity of entrepreneurs to invest rises; when the real interest rate increases, the net present value and the marginal propensity of entrepreneurs to invest decreases.

Assume that NCI, a Ukrainian company, is planning to invest in construction of the mall in Poltava. It is expected that investment costs will be 700 mln UAH in the first year. The investor is planning to earn income after the first year that is 850 mln UAH. Calculate the net present value of this project if the real interest rate is 18 %:

$$NPV = \frac{(0 - 700 \text{ mln UAH})}{(1 + 0.18)} + \frac{(850 \text{ mln UAH} - 0)}{(1 + 0.18)^2} = 18.29 \text{ mln UAH.}$$

Now determine how the net present value of the project changes if the real interest rate decreases by 4 % (from 18 to 14 %):

$$NPV = \frac{(0 - 700 \text{ mln UAH})}{(1 + 0.14)} + \frac{(850 \text{ mln UAH} - 0)}{(1 + 0.14)^2} = 39.81 \text{ mln UAH.}$$

The example above proves that there is an inverse relationship between the real interest rate and both the net present value and the marginal propensity of entrepreneurs to invest.

## Glossary

**Saving** is a part of disposable income that is not consumed now.

**Investment** is a flow of costs aiming to provide additional income (usually in the form of profit, interest, dividends or rent).

**Gross investment** is the value of all investment goods, including the value of depreciation.

**Net investment** is the value of investment goods, excluding the value of depreciation.

**Induced investment** is injections caused by the increase in the real GDP.

**Unplanned investment** is mainly unexpected investment in stocks.

**Investment multiplier effect** states that an initial change in investment positively impacts on real GDP.

**Investment accelerator effect** states that an initial change in real GDP positively impacts on investment.

**Net profit rate** is the ratio between the net profit from the investment project and the total investment in the project.

**Net present value** is the difference between the net value of the expected profit and the net value of the expected costs.

### Questions for self-assessment

1. What are the key features of a closed private economy?
2. What are the basic determinants of saving in the closed private economy?
3. What is investment? What types of investment do you know?
4. Give at least four examples of investment goods.
5. Explain the Keynesian investment function. What are the weaknesses of the Keynesian investment theory?
6. What are the causes of investment instability?
7. Distinguish between the investment multiplier and the investment accelerator.
8. What will the investment multiplier be if the marginal propensity to save is 0.3?
9. What does the expected rate of return show? Why should businesses calculate it?
10. Distinguish between the accounting and net present value approaches to the estimation of profitability of investment projects. What are the merits and disadvantage of each one?

## Review questions

1. Explain verbally and show graphically how each of the following events influences the saving curve:

- a) the expected inflation;
- b) a pessimistic outlook on the domestic political climate;
- c) a decrease in the retirement age;
- d) an increase in the taxes on property;
- e) a decrease in consumers' expectations about their future incomes;
- f) cancellation of social security.

2. What is the role of financial institutions (commercial banks, thrifts, mutual fund companies and securities firms) in the transformation of the households' saving into investment?

3. Explain verbally and show graphically how each of the following events influences the investment demand curve:

- a) technological advance;
- b) an optimistic outlook on the growth of population;
- c) a wave of immigration;
- d) raising the land tax;
- e) an increase in operating costs;
- f) investment tax credit.

4. To accelerate economic growth, the government consider to reinstate a 12 % investment tax credit. It will apply to purchases of all new capital goods. Would you advocate or oppose that decision if you were a lobbyist for the following enterprises:

- a) PJSC "Daewoo";
- b) PJSC "Kharkiv Machine Building Plant "Svet Shakhtyora";
- c) SE "Malyshev plant";
- d) SE "Ukrzaliznytsia";
- e) company "Lifecell";
- f) PJSC "Kriukov Railway Car Building Works" (KVSZ).

5. Why is the investment multiplier in the Ukrainian economy higher than the investment multipliers in the advanced economies such as American, British, Japanese and French?

6. Assume that an enormous downturn in investment spending was almost completely matched by the sharp drop in households' consumption in the country A. How will the overall economy of the country A respond? How will investment and saving in that economy balance?



7. Show graphically how the multiplier effect acts in the different zones of the short-run aggregate supply curve:

- a) the Keynesian zone;
- b) the intermediate zone;
- c) the neoclassical zone.

## Tests

1. Which of the following equations is(are) the key characteristic(s) of the private closed economy:

- a)  $C = S$ ;
- b)  $S = I$ ;
- c)  $Y_d = C + S$ ;
- d) all the above mentioned?

2. Which of the following does not belong to investment goods:

- a) refrigerator;
- b) automobile;
- c) house;
- d) tea?

3. The investment demand curve shows:

- a) a positive relationship between the real interest rate and investment;
- b) a positive relationship between the nominal interest rate and investment;
- c) a negative relationship between the real interest rate and investment;
- d) a negative relationship between the nominal interest rate and investment.

investment.

4. Which of the following events shifts the investment demand curve to the left:

- a) a reduction in rent;
- b) a reduction in energy resources charges;
- c) an increase in labor costs;
- d) an optimistic outlook on the domestic political climate?

5. Marginal propensity to save is calculated as:

- a)  $MPS = \frac{\Delta S}{\Delta Y_d}$ ;
- b)  $MPS = \frac{\Delta Y_d}{\Delta S}$ ;

c)  $MPS = \frac{S}{Y_d}$ ;

d)  $MPS = \frac{\Delta Y_d}{\Delta S}$ .

6. The investment multiplier is calculated as:

a)  $m_I = \frac{1}{MPS}$ ;

b)  $m_I = \frac{1}{MPC}$ ;

c)  $m_I = \frac{1}{1-MPS}$ ;

d) both b) and c).

7. The multiplier effect states that:

a) a change in investment leads to a larger change in real GDP;

b) a change in investment leads to a larger change in nominal GDP;

c) a change in real GDP leads to a larger change in investment;

d) a change in nominal GDP leads to a larger change in investment.

8. The author of the accelerator theory is:

a) J. Keynes;

b) I. Fisher;

c) P. Harrod;

d) E. Hansen.

9. The investment accelerator is inverse to:

a) the marginal propensity to consume;

b) the average propensity to save;

c) the money multiplier;

d) the investment multiplier.

10. If the investment multiplier is 2.5, the investment accelerator is:

a) 0.25;

b) 0.4;

c) 1.25;

d) 2.5.

Answers: 1d; 2d; 3d; 4c; 5a; 6a; 7b; 8d; 9d; 10b.

## 9. Total expenditures and GDP

The aim of the section is to form students' knowledge of how to define the macroeconomic equilibrium using the mechanism of consumption, savings and investments as well as acquire skills in the use of the multiplier effect in the economy.

9.1. The "expenditures – output" model.

9.2. The "withdrawal – injection" model.

9.3. The multiplier and accelerator concept.

9.4. The equilibrium GDP under different levels of employment.

**Key terms:** gross domestic product (GDP), expenditures, output, withdrawal, injections, Keynesian cross, macroeconomic equilibrium, models of macroeconomic equilibrium, multiplier, accelerator, inflation gap, recession (deflation) gap.

### 9.1. The "expenditures – output" model

The "expenditures – output" model is the method to determine the GDP equilibrium provided that the total expenditures are equal to the generated GDP. Let's consider how the mechanism of this model works in a closed economy.

In the "expenditures – release" model, the total expenditures (E) play the role of the aggregate demand, i.e. consumption, investments and government procurement of goods and services ( $E = C + I + G$ ), while the actually generated GDP (Y) is seen as the aggregate supply. At the same time, one should remember that consumption is the expenditures of the population on consumer goods; investments are the expenditures of the companies and enterprises on equipment, raw materials and others needs that are necessary to expand production; government procurements of goods and services are government expenditures. Therefore, the total consumption or total expenditures of companies, enterprises and the government is the sum of  $C + I + G$ . We consider the total expenditures in the economy as

planned – this means that households, enterprises, and the government plan their expenditures in accordance with solvent demand.

*The economic equilibrium* is the equilibrium between the planned total expenditures (E) and the generated, or actual, GDP (Y).

In Fig. 9.1, the income – GDP, is indicated on the horizontal axis and the total expenditures – on the vertical axis.

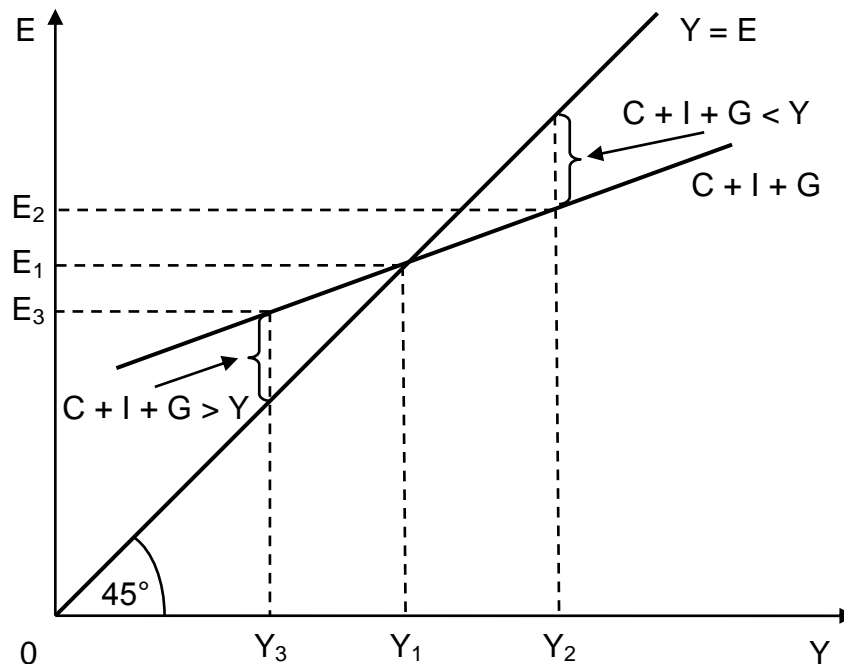

Fig. 9.1. The "expenditures – output" model

The  $Y = E$  line shows the situation when the total produced GDP is consumed by the population, the companies and the government, i.e. it is equal to their expenditures. At any point on this line, the total expenditures are equal to the generated income. The line  $C + I + G$  displays the total expenditures. At the point with coordinates  $(Y_1; E_1)$ , these lines intersect, it means equilibrium is achieved between the generated GDP and the total expenditures and equilibrium in the economy when the demand is equal to the supply ( $AD = AS$ ).

When, in the economy, GDP is generated in the amount of  $Y_2$ , a situation arises when all goods and services are not going to be sold, since the total expenditures are less than the generated GDP ( $C + I + G < Y$ ) and  $AD < AS$ . In order to prevent goods and services from "overstocking" or, otherwise, not becoming inventory, manufacturers reduce the production of goods and services. GDP declines to  $Y_1$ , where the income and the total

expenditures are aligned. Accordingly, the equilibrium is achieved in the economy.

In the case when GDP is generated in the amount of  $Y_3$ , a situation arises when the amount produced is less than required by the economy ( $C + I + G > Y$ ) and  $AD > AS$ . The increased demand  $C + I + G$  generates incentives to increase the production, therefore, GDP is gradually increasing to  $Y_1$  and the economy again achieves the equilibrium of the income and the total expenditures and, accordingly,  $AD = AS$ .

So, *equilibrium* GDP is such a volume of production that is sufficient for consumers, producers and government. With equilibrium GDP, *the total amount of produced goods is equal to the total amount of purchased goods* (consumer, investment and government procurement). The economy is constantly gravitating towards equilibrium as to its natural norm. This means that in the case, when the total expenditures exceed GDP and there is an unplanned decrease in inventories, manufacturers are interested to increase production to the level of the total expenditures. When, on the contrary, the total expenditures are less than GDP and there is an unplanned increase in inventories, manufacturers are forced to reduce production to the level of the total expenditures.

## 9.2. The "withdrawal – injection" model

The "withdrawal – injection" model is the definition of the equilibrium GDP provided the equality of withdrawal and injection in the economic cycle.

Withdrawal is the part of the current income that is not allocated for the total expenditures and thus reduces them. The injection is everything that increases the flow of expenditures (except consumer expenditures that refer neither to injections nor to withdrawals).

For example, the growth of investment increases the total expenditures (aggregate demand), provides additional income for producers, and serves as an incentive to increase national production. The growth in savings reduces the total expenditures and may lead to a reduction in production.

For simplicity, we consider the performance of the model mechanism for the private economy ( $Y = C + I$ ). We also take into account that besides

planned investments, unplanned investments may arise in the economy. Planned investments are investments that enterprises plan to invest in production in accordance with their demand. Unplanned investments are investments that enterprises are forced to make in case of excess of actually produced GDP over the total expenditures (subsection 9.1). Actual investments in the economy are equal to the sum of planned investments and unplanned investments:

$$I_{\Sigma} = I + I', \quad (9.1)$$

where  $I_{\Sigma}$  is the actual investments;

$I$  is the planned investments;

$I'$  is the unplanned investments.

In the private economy, savings are considered as withdrawals – they are not spent on consumption and reduce total expenses in the economy.

In contrast to savings, planned investments can be considered as injections – they increase expenses in the "income-expense" flow.

In the case of equal volume of savings and investments ( $S = I$ ), withdrawals are equal to injections and there is an ideal situation in the economy. Losses in total expenditures in the form of savings are compensated by an increase in expenses in the form of investments. Therefore, total expenditures are equal to actual GDP that is equilibrium at the same time.

If the withdrawals from income in the form of savings exceed investment injections in expenses ( $S > I$ ), then total expenditures are less than total incomes or actual GDP. Since total expenditures determine equilibrium GDP, this means that actual GDP exceed equilibrium GDP.

On the other hand, if the withdrawals from income in the form of savings are less than the investment injections into expenses ( $S < I$ ), the total expenses exceed the actual GDP. This means that actual GDP is less than equilibrium GDP.

*Equilibrium GDP is one that is produced in terms of equilibrium of the volume of savings and the volume of planned investments.*

Determining the equilibrium GDP with the use of the "withdrawal – injection" model is graphically presented in Fig. 9.2.

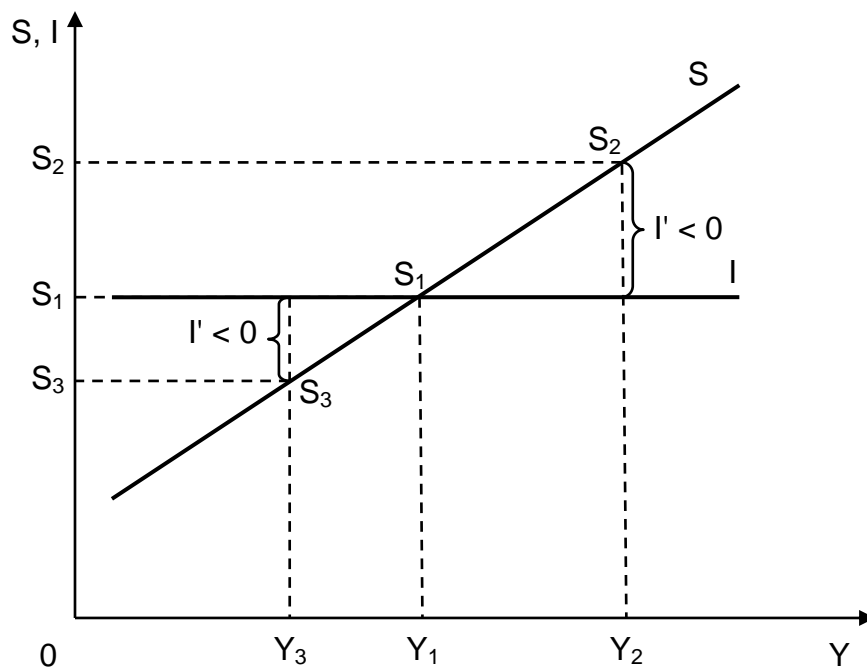

Fig. 9.2. The "withdrawal – injection" model

In Fig. 9.2, GDP ( $Y$ ) is indicated on the horizontal axis while the vertical axis represents savings and investment ( $S, I$ ). Line  $S$  determines the savings of the population, line  $I$  is planned investments, which for simplicity is unchanged (therefore this line is horizontal). The output  $Y_1$  is equilibrium, because it is made under conditions when savings are equal to planned investments ( $S_1 = I$ ), and unplanned investments are equal to zero ( $I' = 0$ ). In fact this means that the population saves in the amount of  $S_1$ , and enterprises invest in the amount of  $I$ .

If the savings of the population ( $S_2$ ) exceed the planned investments ( $I' > 0$ ), this means that the population saves more than enterprises invest and, accordingly, produce ( $Y_2$ ). Actually unrealized goods and services create inventories or unplanned investments. Production declines from  $Y_2$  to  $Y_1$ . A decrease in production entails an increase in unemployment, which in turn, leads to a decrease in income. The decline in income causes a reduction in savings. This happens until equilibrium is reached at the point  $(Y_1, S_1)$ .

If savings ( $S_3$ ) are less than planned investments ( $I' < 0$ ), a situation arises when the population saves less than enterprises invest. Actually the population, reducing savings, consumes more. This encourages enterprises to increase the production volumes, the output of additional products, which increases GDP and promotes employment growth. Income increases, so does the saving, until an equilibrium is reached at the point  $(Y_1, S_1)$ .

So, only at the point  $(Y_1, S_1)$  such GDP is achieved where there is no overproduction or shortage of goods. The equilibrium amount of savings and investments determines the optimal size of GDP.

The considered model is simplified. In the case of the closed regulated economy, the withdrawals from income are referred to taxes and public expenditures are related to injections:

$$S + T = I + G, \quad (9.2)$$

where S is savings;

T is taxes;

I is investments;

G is government spending.

For the open economy, withdrawals include not only savings and taxes but also imported goods and services, since import costs reduce costs in the domestic economy. Exports are classified as injections, since exported goods increase aggregate demand:

$$S + T + Im = I + G + Ex, \quad (9.3)$$

where S is savings;

T is taxes;

Im is import;

I is investment;

G is government spending;

Ex is export.

### **9.3. The multiplier and accelerator concept**

The multiplier effect in the economy is due to the fact that the costs of one economic entity must turn into the income of another economic entity that spends part of this income, creating income for a third entity, etc. As a result, the total amount of income is greater than the initial amount of expenses.

A change in income (GDP) is affected by a change in the total expenditures caused by a change in consumption, in a volume of investment, tax revenue and government spending on goods and services, or in the volume of export.



A *multiplier* is a coefficient which can be used to find out how many times income changes (increases or decreases) due to a change (an increase or a decrease) in the total expenditures or any component of the total expenditures as well as money supply, taxes, bank reserves and etc.

For example, in the economy there are such multipliers:

1) *the consumption multiplier* which shows how an increase in spending on consumer goods causes an increase in income;

2) *the credit multiplier* which establishes the relationship between the growth of credit and the growth of bank deposits, between the growth of credit and the growth of cash in circulation;

3) *the bank multiplier* which establishes the relationship between the growth of bank deposits and the growth of the money supply;

4) *the investment multiplier* which shows the dependence of the changes in income due to changes in investments

5) *the tax multiplier* which shows the inverse relationship between the amount of taxes and income, etc.

All these multipliers have a two-way effect – both in the direction of increasing and decreasing of income.

*The multiplier of the total expenditures* shows that with an increase in the total amount of expenses, the income increases by the amount M in times greater than the increase in expenses:

$$M = \frac{\Delta Y}{\Delta E}, \quad (9.4)$$

where M is the multiplier;

$\Delta Y$  is the increase in revenue;

$\Delta E$  is the increase in the total expenditures.

It should also be noted that, firstly, the effect of multiplication is possible only in a part-time economy, where GDP is less than the potential level. This is due to the fact that an increase in income (GDP) requires labour reserves and production capacities. Secondly, this effect acts in the short term and gradually decreases under the influence of inflation.

*The multiplier effect* is a powerful tool for government regulation of the economy.

Let's show graphically how the change in investment affects the value of national income. In this case, the effect of the multiplier of additional

investments is clearly visible. It is supposed that investments in society rise to a new level that is equivalent to a shift of the investment curve up. In Fig. 9.3 it is noted that a new point of economic equilibrium  $E'$  has been established in society where there is an increase in savings and an increase in national income.

However, at the same time, Fig. 9.3 demonstrates that the increase in national income is greater than the increase in investment.

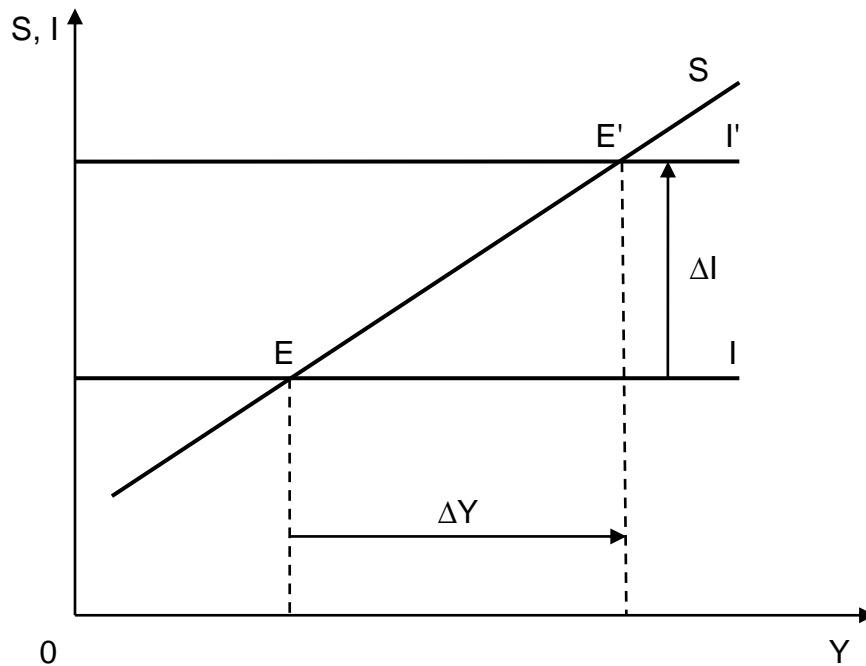

Fig. 9.3. **The effect of the investments multiplier**

The coefficient that shows the excess of income growth over investment growth is the multiplier.

The multiplier acts both in the expansion and compression mode of national income, depending on the expansion and contraction of investments. The level of national income at full employment is a desirable economic goal. Deviation from this level means an inflationary or deflationary (recessionary) gap. It is discussed in subsection 9.4.

The multiplier effect is caused not only by changes in investments but also changes in the level of savings (Fig. 9.4).

So, an attempt to save more is indicated in an upward shift of the savings curve from  $S$  to  $S'$ . Graphically, this shift creates a surplus of savings over planned investments at a current income level of  $Y_1$ .

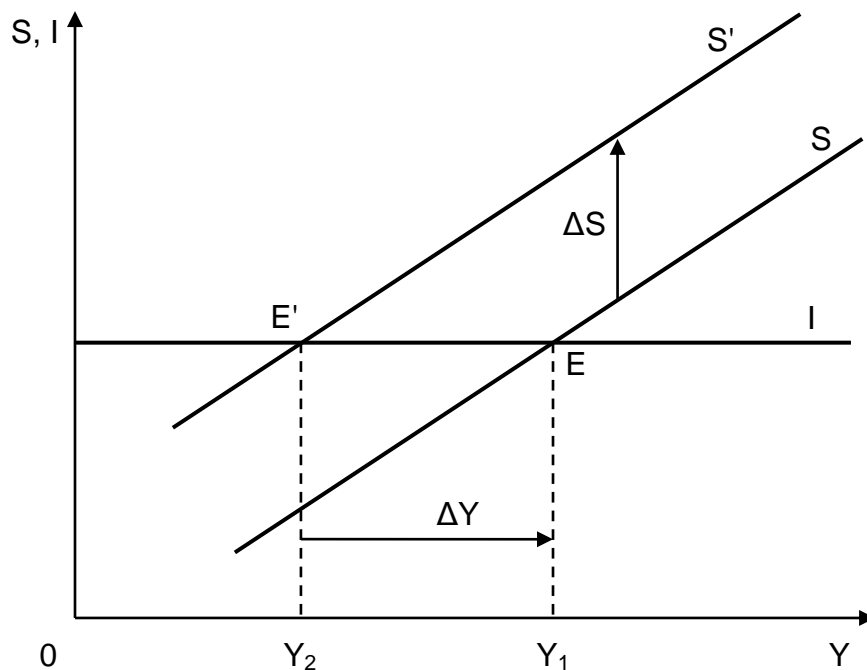

Fig. 9.4. The paradox of thrift

However, the multiplier effect caused by a slight increase in savings (lower consumption) results in a much larger decrease in equilibrium income, in this case,  $Y_2$ .

Thus, it leads to the paradox of thrift, according to which an increase in savings leads to a decrease in the equilibrium level of income.

There are conditions under which the paradox of thrift is not observed:

- 1) in conditions of the demand inflation, since an increase in savings affects a fall in the price level;
- 2) if additional savings are invested.

So far, it was a matter of autonomous investment. This situation is some simplification of the relationships that exist across the national economy. Actually, there is an interaction (mutual influence) of the investments and the income.

Autonomous investments made in the form of an initial "injection", due to the multiplier effect, lead to an increase in national income. The revival of business activity and employment growth lead to the increase in the propensity to invest in different groups of entrepreneurs. These investments are called *derivatives (induced, stimulated)*. Derivative investments enhance economic growth and accelerate it, which is called *the accelerator effect*.

The simplest accelerator formula is:

$$v = \frac{\Delta I}{\Delta Y}, \quad (9.5)$$

where  $v$  is the acceleration coefficient;

$\Delta I$  is derivative investments;

$\Delta Y$  is income growth due to autonomous investment.

The interaction of the multiplier and the accelerator occurs in the following way. Initially, autonomous investments  $A$  cause an increase in  $Y$  with an intensity equal to the value of the investment multiplier. The increase in  $Y$  causes a flow of derivative investments  $I$  that depends on the accelerator power. Joining autonomous investments, derivative investments again generate the effect of multiplication that, in its turn, stimulates the effect of acceleration and so on.

The theory of the multiplier-accelerator is used by economists to justify the idea of government intervention in the economy. The argument is as follows: as a result of state regulation (direct – through investment or indirect – through fiscal policy), consumer demand increases, it multiplies the new demand for goods and services that, ultimately, leads to the increase in national income.

#### **9.4. The equilibrium GDP under different levels of employment**

The equilibrium conditions in the economy depend on the relationship between the total expenditures and the potential output (GDP). *Equilibrium* occurs when *total expenditures are equal to potential GDP*.

However, in the economy, two situations may arise: either total expenditures are not enough to purchase potential GDP or total expenditures exceed potential GDP.

Let's consider the first situation where total spending is less than potential GDP. This situation is called a recession or deflation gap. Graphically, this situation is shown in Fig. 9.5.

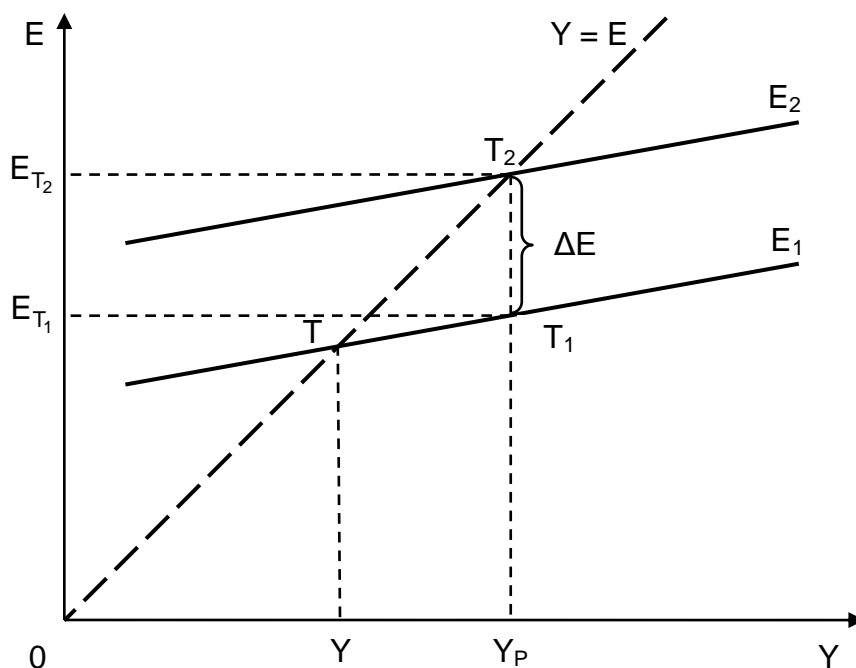

Fig. 9.5. **The recession or deflation gap**

As can be seen in Fig. 9.5, actual GDP ( $Y$ ) is less than potential GDP ( $Y < Y_p$ ). Consequently, unemployment is observed in the economy. Actual total expenditures correspond to line  $E_1$ . Equilibrium in the economy is achieved at the point  $T$  with GDP equal to  $Y$  and total expenditures of the volume  $E_1$ .

Potential GDP ( $Y_p$ ) corresponds to expenditures of the volume  $E_2$ . Graphically, the recession gap is the vertical distance between the lines  $E_1$  and  $E_2$ , on the graph it is indicated by  $\Delta E$  ( $E_{T_2} - E_{T_1}$ ).

The quantitative recession gap is the amount by which the actual total expenditures should increase in order to ensure that actual GDP grows to potential GDP without price increases. (GDP growth is possible because of underemployment in the economy.)

The second situation is where total expenditures exceed potential GDP and there is an excess of aggregate demand. It is shown in Fig. 9.6. This situation is called the inflation gap.

As seen in Fig. 9.6, actual GDP ( $Y$ ) is greater than potential GDP ( $Y > Y_p$ ). Actual total expenditures correspond to the line  $E_2$ . Equilibrium in the economy is reached at the point  $T_1$  with GDP equal to  $Y$  and total expenditures of the volume  $E_2$ . Such an equilibrium in the economy is very unstable, because, firstly, the economy uses more resources than it has (they have to be borrowed from the outside), and, secondly, excess aggregate demand causes inflation.

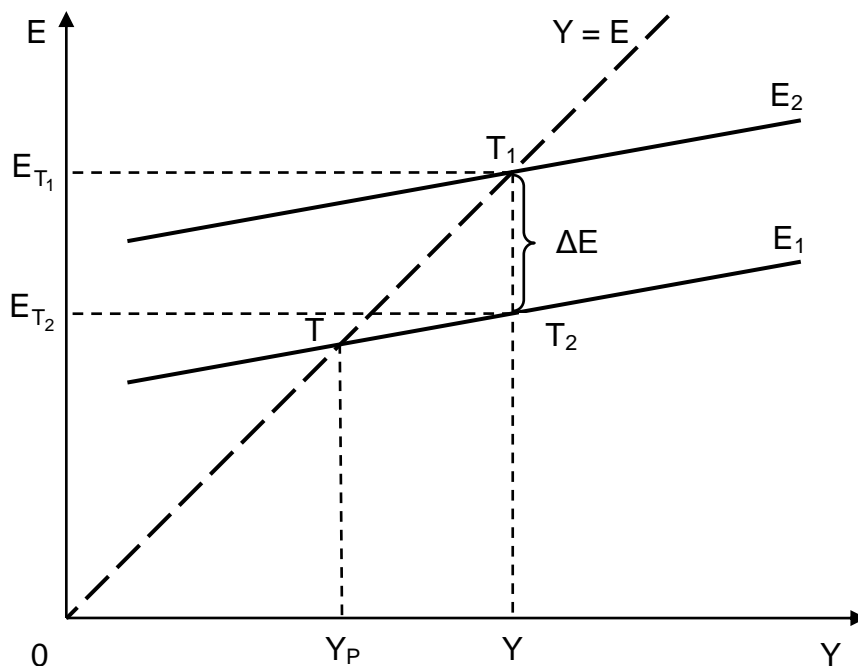

Fig. 9.6. The inflation gap

Potential GDP ( $Y_P$ ) corresponds to expenditures of the volume  $E_1$ . Graphically, the inflation gap is the vertical distance between the lines  $E_1$  and  $E_2$ ; on the graph it is indicated by  $\Delta E$  ( $E_{T_1} - E_{T_2}$ ). The quantitative inflation gap is the amount by which the actual total spending needs to be reduced in order to bridge the GDP inflation gap while maintaining full employment and ending the inflationary impact of excess aggregate demand on the economy.

### Glossary

**Economic equilibrium according to the "expenditures – output" model** is the equilibrium between the planned total expenditures ( $E$ ) and the generated, or actual, GDP ( $Y$ ).

**Equilibrium GDP according to the "withdrawal – injection" model** is one that is produced in terms of equilibrium of the volume of savings and the volume of planned investments.

**Inflation gap** is the amount by which actual total spending needs to be reduced in order to bridge the GDP inflation gap while maintaining full employment and ending the inflationary impact of excess aggregate demand on the economy.

**Injection** is everything that increases the flow of the expenditures (except consumer expenditures that refer neither to injections nor to withdrawals).

**Multiplier** is a coefficient which can be used to find out how many times income changes (increases or decreases) due to a change (an increase or decrease) in the total expenditures or any component of the total expenditures as well as money supply, taxes, bank reserves, etc.

**Paradox of thrift** is a situation according to which an increase in savings leads to a decrease in the equilibrium level of income.

**Recession gap** is the amount by which actual total expenditures should increase in order to ensure that actual GDP grows to potential GDP without price increases. (GDP growth is possible because of underemployment in the economy.)

**Withdrawal** is the part of the current income that is not allocated for total expenditures and thus reduces them.

### Problems with examples of solution

**Problem 1.** The country's economic system is characterized by the following data: the consumption function has the form  $C = 40 + 0.75Y$ . Planned investments are independent of income and equal to 35 monetary units. Government spending is 30 monetary units. Define:

- a) the level of the equilibrium income for this economy;
- b) the multiplier;
- c) the level of the equilibrium income if government spending increased by 10 monetary units.

*Solution.* a)  $Y = C + I + G$ , because in this problem, the characteristics of the country's economy do not have any data on exports and imports. Substituting the data, we obtain the equation  $Y = 40 + 0.75Y + 35 + 30$ , hence  $0.25Y = 105$ ,  $Y = 420$  monetary units.

b) The multiplier is determined by the formula:

$$M = 1 / (1 - MPC).$$

We find the MPC from the equation  $C / MPC = 0.75$ . Therefore,  $M = 1 / 0.25 = 4$ .

c) The multiplier of public spending is  $M = \Delta Y / \Delta G$ , therefore  $4 = \Delta Y / 10$ ,  $\Delta Y = 25$ .  $Y = 420 + 25 = 445$  monetary units.

**Problem 2.** The graph shows the well-known Keynesian cross, one of the basic models of macroeconomic equilibrium.

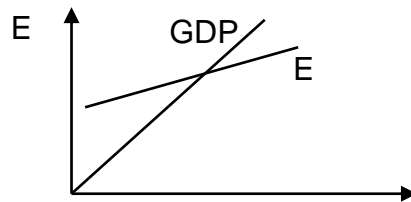

In what coordinate system is the Keynesian cross built? What does a bisector and a line intersecting the bisector mean? Which of these curves can be interpreted as aggregate demand, and which as aggregate supply? Why?

*Solution.* The horizontal axis is the income, or output. The y-axis is the total expenditure. The bisector means the geometric place of the points where the aggregate expenditures of the population coincide with income or output. The curve that crosses the bisector indicates the actual expenses of the income received by economic agents.

The bisector can be interpreted as an aggregate supply, because national income is equal to national product. The curve that crosses the bisector can be interpreted as aggregate demand, because this is the total cost.

### Questions for self-assessment

1. Define the difference between actual and planned investments.
2. What methods for determining equilibrium in the economy do you know?
3. What is the Keynesian cross and how is it used to determine equilibrium in the economy?
4. Display graphically the equilibrium model "expenditures – output" and explain it.
5. What is considered to be withdrawal in macroeconomics and what are injections?
6. Depict graphically the "withdrawal – injection" equilibrium model.
7. What is the multiplier effect in the economy?
8. What is an investment multiplier?
9. Explain the essence of the principle of acceleration.
10. Under what conditions does a recession gap arise in the economy?



## Review questions

1. Explain with the help of a graph how a multiplier effect manifests itself in different parts of the aggregate supply curve:
  - a) in a situation far from the state of full employment, that is, on the horizontal segment;
  - b) in a state that is approaching a situation of full employment, that is, on the intermediate segment;
  - c) in a state of full employment, that is, on the vertical segment.
2. How does the intensity of the multiplier effect depend on the steepness of the savings curve? Demonstrate this effect using a graph, explain the effect of the multiplier.
3. Give a graphical interpretation of the deflationary (recessionary) and inflationary gaps in the economy. Explain how this can be reflected in production and employment in a country's economy.
4. Identify graphically and quantitatively:
  - a) the recession gap;
  - b) the inflation gap.

## Practical tasks

1. Calculate a simple cost multiplier, provided that the available income has increased by 20 billion UAH, and consumption – by 12 billion UAH.
2. Consumption is 40 billion UAH, and unplanned investments are equal to (- 2) billion UAH. Identify planned investments.
3. The country's economy is described by the following data:

$$Y = C + I + G + X_n; C = 300 + 0.8Y_d; I = 200 + 0.2Y; X_n = 100 - 0.04Y; G = 200; T = 0.2.$$

Calculate: a) the equilibrium level of income; b) the value of the cost multiplier.

4. The deflation gap is 5 billion monetary units, and the actual GDP is 100 billion monetary units. The marginal propensity to consume is 0.8. Calculate the value of potential GDP.

5. Actual total expenditures in a mixed closed national economy are 120 billion monetary units. Potential GDP is 100 billion monetary units. The marginal propensity to consume is 0.8. Find the magnitude of the inflation gap provided that equilibrium is reached in the economy.

### Tests

1. Which of the following macroeconomic values relate(s) to withdrawal from income:

- a) savings of the population;
- b) export of goods and services;
- c) investments in the national economy;
- d) government procurement of goods and services?

2. Which of the following macroeconomic values relate(s) to injections in total costs:

- a) savings of the population;
- b) import of goods and services;
- c) tax payments;
- d) government procurement of goods and services?

3. A recession gap is characterized by:

- a) the deficit of total expenses;
- b) the excess of total expenses;
- c) the equilibrium GDP greater than potential GDP;
- d) all answers are incorrect.

4. The "withdrawal – injection" method is:

a) identification of equilibrium GDP through the determination of its real volume at which total costs are equal to the national product;

b) determination of equilibrium GDP by finding its volume at which the withdrawal volume is equal to the volume of injections;

c) the macroeconomic principle according to which the aggregate supply of goods creates an equal aggregate demand for these goods;

d) the ratio of changes in equilibrium GDP to changes in investment.

5. The cost multiplier is:

a) the macroeconomic principle according to which the aggregate supply of goods creates an equal aggregate demand for these goods;

b) the ratio of changes in equilibrium GDP to changes in investment;

c) identification of equilibrium GDP by determining its real volume at which total expenditures are equal to the national product;

d) the effect of changes in total expenditures on equilibrium GDP.

6. The "expenditures – output" model is:

a) identification of equilibrium GDP through the determination of its real volume at which total costs are equal to the national product;

b) the effect of changes in total expenditures on equilibrium GDP;

c) the macroeconomic principle according to which the aggregate supply of goods creates an equal aggregate demand for these goods;

d) the ratio of changes in equilibrium GDP to changes in investment.

7. If the aggregate demand exceeds the real GDP and this aggregate demand cannot be satisfied due to full employment, this indicates:

a) the inflation gap;

b) the deflation gap;

c) the absence of unemployment in the country;

d) the absence of inflation and unemployment in the country.

8. Macroeconomic equilibrium in a closed economy, taking into account the participation of the state, is determined by the equation:

a)  $C + I = G + S$ ;

b)  $C + I = G + NE$ ;

c)  $I + G = S + T$ ;

d)  $C + G = S + T$ .

9. Withdrawal in an open circular flow model is:

a)  $I + G + EX$ ;

b)  $S + T + IM$ ;

c)  $C + G + S$ ;

d)  $NE + T + IM$ .

10. Injections in an open circular flow model are:

a)  $I + G + EX$ ;

b)  $S + T + IM$ ;

c)  $C + G + S$ ;

d)  $NE + T + IM$ .

Answers: 1a; 2d; 3a; 4b; 5d; 6a; 7a; 8c; 9b; 10a.

## 10. Economic dynamics

In macroeconomics, economic growth is one of the most widespread terms. In this section, the essence and the main types of economic growth as well as the factors impacting on its dynamics in the market economy are considered. The difference between economic growth and economic development is studied, the Keynesian and neoclassical growth models are described, compared and contrasted.

The focus is also on the essence, types and structure of the business cycle. So, the phases of business cycles and their characteristics are examined and the information about the features of modern business cycles is provided.

- 10.1. The sources of economic growth.
- 10.2. The main models of economic growth.
- 10.3. The problems of economic growth of Ukraine.
- 10.4. Economic cycles.

**Key terms:** economic growth, endogenous economic growth, economic development, sustainable development, gross domestic product (GDP) per capita, Cobb – Douglas production function, neoclassical growth model, Keynesian growth model, Harrod – Domar growth model, Solow residual, accumulation golden rule, economic fluctuations, business cycle, expansion (boom), peak, contraction (recession), depression, Kondratiev long waves, Kuznet's construction cycle, exogenous shocks.

### 10.1. The sources of economic growth

Economic growth is an increase in real GDP. Modern economists differentiate three groups of sources of economic growth (Fig. 10.1).

Let's consider extensive and intensive sources of economic growth more precisely because they are the most widespread ones in a modern business world. Extensive sources of economic growth are the sources related to the increase in key productivity factors – labor, capital, land and entrepreneurial ability. If a society uses a discovered coalfield to produce more goods and services, it means that economic growth of this society is based

on the extensive factors. Extensive factors were broadly used in the South Asian and Soviet Union economies in the 1960s and, today, many countries, including Brazil, Russia, Saudi Arabia and the United Arab Emirates (UAE), increase total output using more human and natural resources. According to INSED, three-fourth of the UAE economic growth came from more oil in 2018.

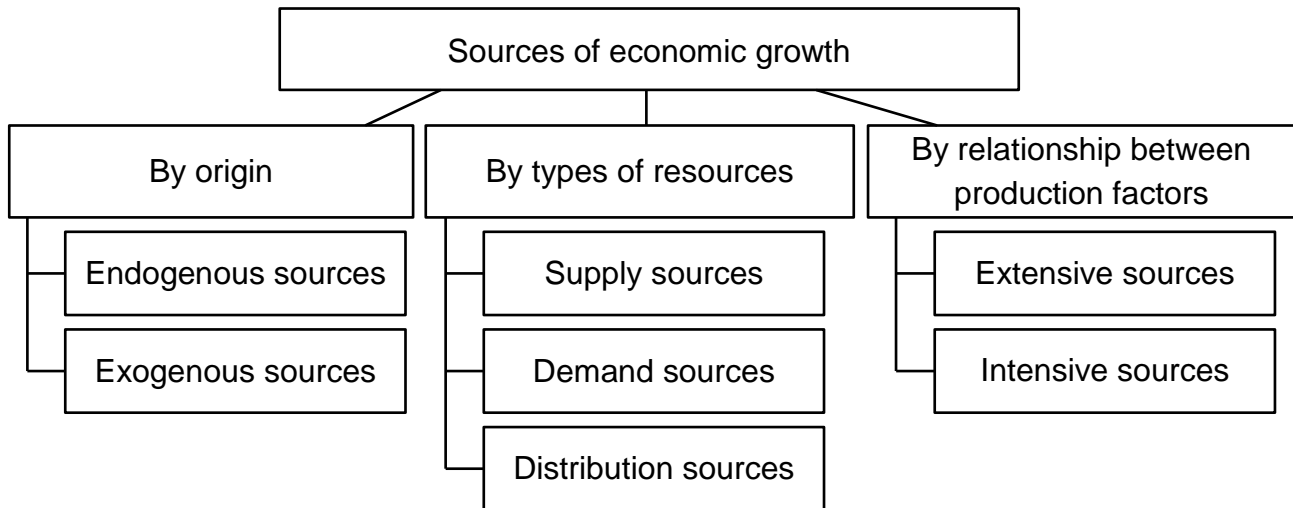

Fig. 10.1. **Classification of the sources of economic growth**

At the same time, governments of developed countries use another source to accelerate economic growth: they increase real GDP by raising the productivity of inputs. Note that productivity rises when the health, education, training of employees are significantly improved; when employees have improved physical capital (equipment, machines, engines, etc.) with which to work; when the process of production of final goods is better organized and managed; when human and natural resources (gas, crude oil, electricity, etc.) are reallocated from less efficient sectors to more efficient sectors of the national economy. For example, when a society increases the number of the employed without changes in their competences and abilities, it means that economic growth of that society is based on the extensive factors. Add that over time human productivity tends to increase all around the world. According to INSED, today, about three-fourth of the developed economies' growth results from technological advance and innovation. That growth is measured by the Global Innovation Index (GII). The leaders in the world economy in terms of GII are Switzerland (GII = 67.69), Sweden (GII = 63.82), the Netherlands (GII = 63.36), the United Kingdom (GII = 60.89), Denmark (GII = 58.82) [20].

The choice of the sources of economic growth implies determination of the quantitative relationship between the size of resources and the increase in their productivity. This relationship can be described by the production function that is the simplest economic growth model. As has been discussed in section 3, labor and capital are the most important production factors. So the two-factor production function can be mathematically described as:

$$Y = f (C, L), \quad (10.1)$$

where Y is total output (or nominal GDP);

f is the function;

C is physical capital;

L is labor.

As we see, according to equation (10.1), key production factors (capital, labor) positively impact on the size of total output (or nominal GDP): when the size of physical capital or labor increases by 1 %, nominal GDP also increases by 1 %; when the size of physical capital or labor decreases by 1 %, nominal GDP also decreases by 1 %.

According to the neoclassical economic theory, land is also a very important production factor. So the three-factor production function is mathematically described as:

$$Y = f (K, L, D), \quad (10.2)$$

where D is land.

Nowadays successful macroeconomic changes are mainly related to the technological advance. Besides, managerial innovation provides a high level of economic development and increase in human productivity by several times. For that reason, the factor production function can be completed in this way:

$$Y = f (K, L, D, T, X, N), \quad (10.3)$$

where T is technological advance, innovation;

X is public institutions;

N is the environment.

There are many indicators characterizing economic growth, in particular the real GDP growth, the economic growth rate, GDP per capita and the human development index.

The real GDP growth is calculated as:

$$\Delta Y = Y_1 - Y_0, \quad (10.4)$$

where  $\Delta Y$  is the real GDP growth;

$Y_1$  is the real GDP in the base period;

$Y_0$  is the real GDP in the given period.

The economic growth rate is calculated as:

$$\text{EGR} = \frac{Y_1 - Y_0}{Y_0}, \quad (10.5)$$

where EGR is the economic growth rate.

The dynamics of the economic growth rate in Ukraine in 2000 – 2018 is given in Fig. 10.2. We see that the dynamics of real GDP in Ukraine was not stable, it fluctuated: sometimes real GDP rose (2001 – 2004, 2010 – 2011, 2016) sometimes real GDP dropped (2007 – 2008, 2013 – 2015) [202].

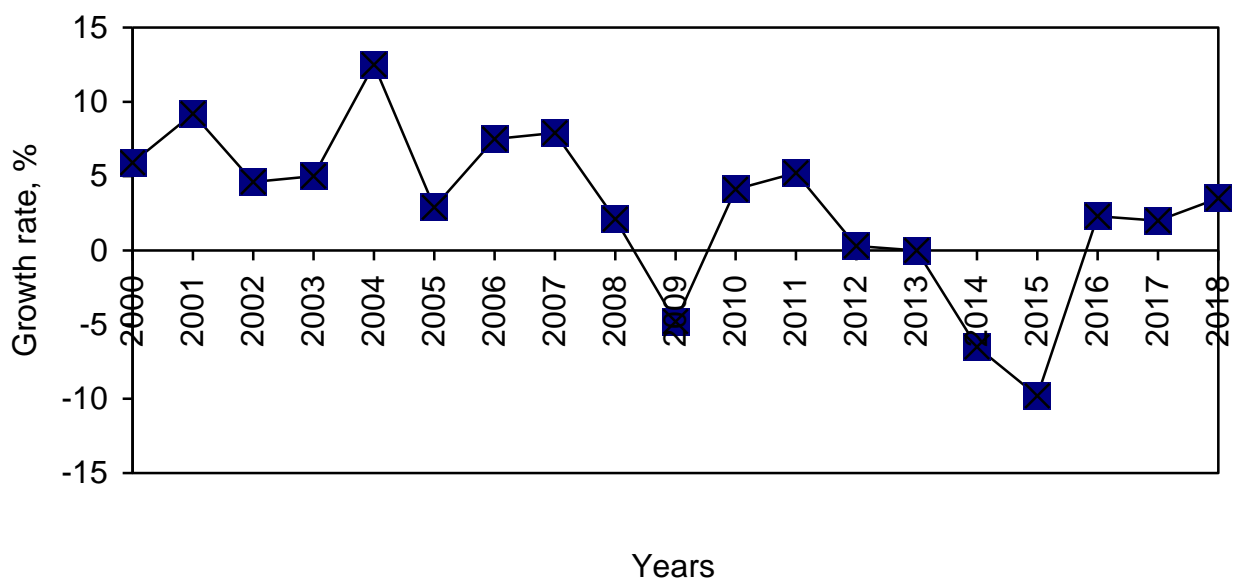

Fig. 10.2. The dynamics of economic growth in Ukraine

GDP per capita is calculated as:

$$Y_C = \frac{Y}{P}, \quad (10.6)$$

where  $Y_C$  is GDP per capita;

$Y$  is real GDP;

$P$  is population of the country.

#### Interesting to know

As we know, Luxembourg ( $Y_C = \$120\,061$ ), Switzerland ( $Y_C = \$86\,835$ ), Iceland ( $Y_C = \$84\,675$ ), Macao SAR ( $Y_C = \$83\,844$ ), Norway ( $Y_C = \$82\,711$ ), Ireland ( $Y_C = \$80\,641$ ), Qatar ( $Y_C = \$66\,202$ ), Denmark ( $Y_C = \$63\,380$ ), United States of America ( $Y_C = \$61\,152$ ), Singapore ( $Y_C = \$61\,767$ ) were the world leaders in terms of GDP per capita in 2018. In contrast, Eritrea ( $Y_C = \$1\,111$ ), Chad ( $Y_C = \$920$ ), Ethiopia ( $Y_C = \$910$ ), Uganda ( $Y_C = \$711$ ), Niger ( $Y_C = \$510$ ), Mozambique ( $Y_C = \$472$ ), Burundi ( $Y_C = \$340$ ) and South Sudan ( $Y_C = \$246$ ) were the world losers in terms of GDP per capita in 2018.

The Human Development Index is an integral indicator used to estimate the level of economic, social, educational and cultural development of the country. The Human Development Index varies from 0 to 1 and includes three partial indicators:

- 1) gross domestic product;
- 2) the education index that is determined by educational indicators with the share of  $2/3$  and the share of children and youth aged from 6 to 23 who are educated now;
- 3) the longevity index that is determined by life expectancy at birth.

Depending on the value of the human development index, four groups of countries are distinguished: very high human development countries (advanced European countries, in particular Norway (HDI = 0.953), Switzerland (HDI = 0.944), Australia (HDI = 0.939), Ireland (HDI = 0.938), Germany (HDI = 0.936), Singapore (HDI = 0.932), post-communist European countries, in particular Slovenia (HDI = 0.896), the Czech Republic (HDI = 0.888), Poland (HDI = 0.965) as well as the United States (HDI = 0.924), South Korea (HDI = 0.903), Israel (HDI = 0.902)); high human



development countries (many Latin America economies including Cuba (HDI = 0.777), Mexico (HDI = 0.774), Venezuela (HDI = 0.761), Ecuador (HDI = 0.752), Peru (HDI = 0.750)); medium human development countries (mainly Asian countries, namely the Philippines (HDI = 0.699), Indonesia (HDI = 0.694), India (HDI = 0.640), Bangladesh (HDI = 0.608), Pakistan (HDI = 0.562) as well as some African societies, including South Africa (HDI = 0.699), Nicaragua (HDI = 0.658), Ghana (HDI = 0.592), Cameroon (HDI = 0.552)); low human development countries (mostly African countries, in particular Uganda (HDI = 0.516), Senegal (HDI = 0.505), Ethiopia (HDI = 0.463), Chad (HDI = 0.404), Niger (HDI = 0.354)) [250; 207]. Ukraine is a medium human development country which is proved by the data given in the table.

Table

**The dynamics of the human development index and its components in Ukraine**

Indicators	Years								
	2010	2011	2012	2013	2014	2015	2016	2017	2018
Life expectancy at birth, years	68.2	68.5	68.8	69.5	71.0	71.1	72.4	72.0	72.1
Expected years of schooling, years	14.8	14.8	14.8	14.8	14.8	15.3	15.5	15.5	15.5
GDP per capita, PPP, \$	5 938	6 210	6 428	6 384	6 159	7 361	7 729	7 865	7 902
Human development index	0.733	0.737	0.733	0.734	0.743	0.747	0.743	0.745	0.746

The table shows that GDP per capita increased only by \$1964 (or 33.08 %) in 2010 – 2017. In contrast, over the same period, GDP per capita increased by 75 % in Poland, Slovakia and the Czech Republic. Meanwhile, the expected years of schooling increased slightly (from 14.8 years in 2010 – 2014 to 15.5 years in 2016 – 2018). That shows there is a definite improvement in the components of national intellectual capital in Ukraine especially in national educational capital.

There are also three groups of indicators showing changes in real GDP and signalling the size of goods and services to be produced in the future:

- 1) leading indicators;
- 2) coincident indicators;
- 3) lagging indicators.

Leading indicators are the variables that usually change before real GDP changes so they are very helpful for scientists and policymakers to forecast changes in total output. These indicators are the following: the unemployment rate, the real interest rate, the reserve rate, security prices, the number of manufacturers' orders, new construction orders. For example, a decline in the number of manufacturers' orders results in unemployment which, in turn, leads to a drop in real GDP and signals negative perspectives of the economy. In contrast, an increase in the number of manufacturers' orders results in an increase in the number of employed and leads to a rising real GDP and signals positive perspectives of the economy in the future.

Coincident indicators are the variables that tend to change at the same time as real GDP changes. These are the following: disposable income, payroll unemployment, total output, manufacturing profits and trade sales. If the disposable income rises, households can buy more final goods and services which results in an increase in labor demand and allows the scientists and policymakers to forecast an increase in the future trade sales. On the other hand, if disposable income rises, households will obviously buy less goods and services which expectedly results in a decrease in real GDP.

Lagging indicators are the variables that, as a rule, change only after real GDP changes. These are the following: the real interest rate, the inflation rate, the cyclical unemployment rate, the total cost per unit, the size of inventories. For example, when real GDP rises, the labor demand increases and the cyclical unemployment rate will obviously decrease. That demonstrates positive perspectives of the economy in the future. Similarly, when real GDP decreases, the labor demand increases and the cyclical unemployment rate will obviously decrease. It should be noted that lagging indicators are always used along with other two groups of variables to determine the dynamics of economic growth in the country.

Thus, a set of factors determining economic growth cover both basic natural factors and factors developed by humans. If production factors are integrated properly, the economies will be advanced and successful.

Conversely, imbalance in production factors leads to economic crises that occur cyclically in different countries.

## 10.2. The main models of economic growth

There are two groups of models of economic growth: Keynesian and neoclassical (Fig. 10.3).

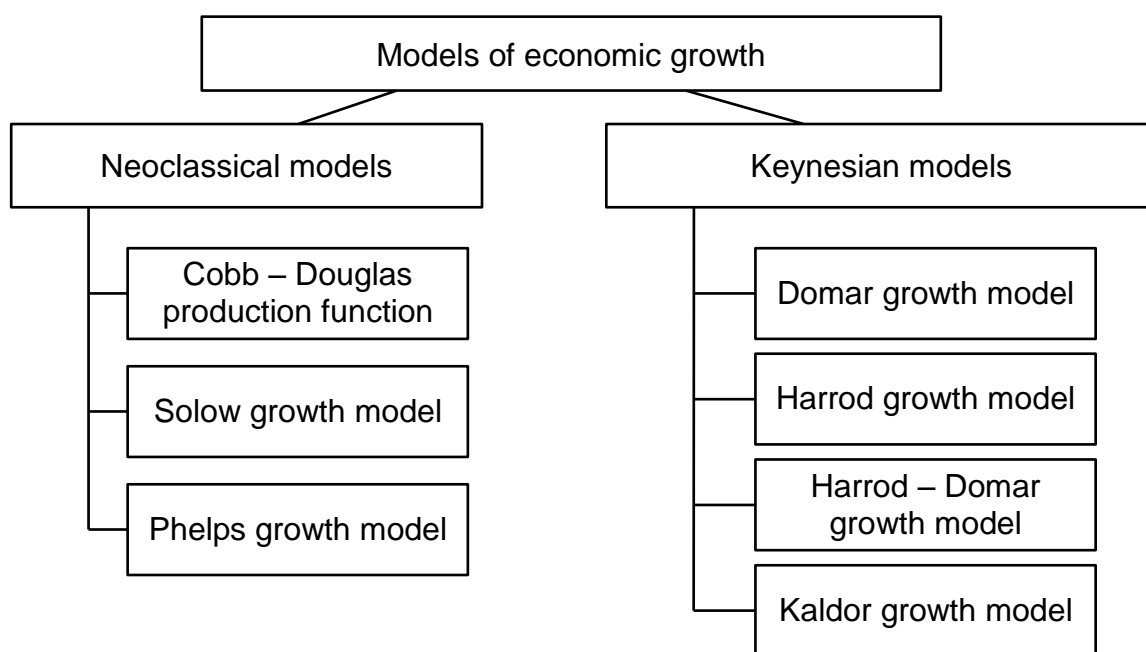

Fig. 10.3. The models of economic growth

Neoclassical models of economic growth (Cobb – Douglas production function, Solow growth model, Phelps growth model) are based on the following statement: there is quantitative relationship between the size of resources and increase in their productivity. It is described as a production function that includes only two factors: capital and labor.

E. Cobb and P. Douglas proposed the following function:

$$Y = A \cdot K^{\alpha} \cdot L^{1-\alpha}, \quad (10.7)$$

$$\text{or } \frac{\Delta Y}{Y} = \frac{\Delta A}{A} + \alpha \frac{\Delta K}{K} + (1-\alpha) \frac{\Delta L}{L}, \quad (10.8)$$

where Y is the pace of economic growth (pace of output);

A is total productivity of production factors;

K is an increase in capital;

L is population growth;

$\alpha$  is the coefficient of elasticity of real GDP to capital ( $0 < \alpha < 1$ ).

### Interesting to know

The Cobb – Douglas production function has been used to estimate the influence of accumulation factors, namely the capital investment and the number of the employed in the national economy, on the economic development of Ukraine under market reforms from 1994 to 2017. This function has been lineared and built using the program complex Excel 2016. The following function has been obtained:

$$Y = 11.4669 + 0.07641X1 - 2.3647X2,$$

where Y is nominal GDP;

X1 is the size of capital investment;

X2 is the number of the employed.

The obtained results show that capital investment positively influences the economic development of Ukraine, but the number of the employed in the national economy negatively affects that process [10].

In turn, R. Solow, another famous American neoclassical economist, took into consideration other factors impacting on economic growth, namely saving and depreciation. Accordingly, the Solow growth model is described as:

$$a) \quad s \cdot y = d \cdot k, \quad (10.9)$$

where s is the saving rate;

d is the depreciation rate;

y(Y/L) is the capital armed labor;

k(K/L) is labor productivity.

$$b) \quad s \cdot f(k) = (d + n) \cdot k, \quad (10.10)$$

where f(k) is the critical size of investment;

n is population growth.

E. Phelps contributed to the modern macroeconomics due to the analysis of the impact of population and technical advance on economic growth in the

long run. He proposed a so-called "adequate change in marginal product of capital" that provides macroeconomic stability and increase in real GDP. This statement is known as Phelps accumulation golden rule:

$$MP_k = \delta + n + g, \quad (10.11)$$

where  $MP_k$  is marginal product of capital;

$\delta$  is depreciation rate;

$n$  is population growth;

$g$  is technical advance.

Keynesian models of economic growth are based on Keynes's ideas which can be summarized in the following statements:

1) aggregate demand forms aggregate supply, so the dynamics of economic growth is determined by the factors of demand, namely minimum wages and household savings;

2) all production factors (capital, labor, land, entrepreneurial ability, science, information, ecology) are not changeable;

3) prices are stable;

4) economic expectations of entrepreneurs are static.

As we know from section 7, according to the Keynesian economic theory, a key function of investment in the closed private economy is to increase real GDP. Due to the multiplier effect, it increases both aggregate demand and employment in the country. J. Keynes paid close attention to the state expenditures, especially the part of them that is distributed to the construction of roads, bridges and dams. That is explained by the following fact: in times of overproduction or crisis it is necessary to form effective demand rather than supply excess goods and services to the market. In other words, Keynes did not analyze the impact of investment on the goods supply. E. Domar, another outstanding American economist, refined and complemented the Keynesian concept.

In particular, Domar developed a one-factor economic growth model that states the relationship between the increase in GDP growth and investment growth. He analyzed the problem of economic growth in the conditions of dynamic equilibrium that is characterized by an increase in production capacity. In the conditions of full employment, in Domar's view, there is an excess labor supply that, in turn, results in the stability of price level in the country. Both investment and real GDP must change at the same

level so equilibrium GDP is proportional to the household saving and marginal productivity of capital. It can be mathematically written as follows:

$$\Delta Y = a \cdot \Delta K, \quad (10.12)$$

$$\text{or } \frac{\Delta Y}{Y} = a \cdot s',$$

$$\Delta Y = a \cdot I, \quad (10.13)$$

where  $a$  is marginal productivity of capital;  
 $I$  is investment.

For example, marginal productivity of capital in the country A is 0.3, marginal propensity to save is 0.2, so economic growth in the conditions of general equilibrium and full employment will equal 6 % ( $\Delta Y = 0.3 \cdot 0.2 = 0.06$  or 6 %).

Domar determined the increase in real GDP using the formula below:

$$\Delta Y = \frac{\Delta I}{s'}, \quad (10.14)$$

where  $\Delta Y$  is the change in real GDP;  
 $\Delta I$  is the change in investment;  
 $s'$  is marginal propensity to save.

The change in aggregate demand depends on the change in investment and is calculated as:

$$\Delta Y = m \cdot \Delta I = \frac{1}{1 - MPC} \cdot \Delta I = \frac{1}{MPS} \cdot \Delta I, \quad (10.15)$$

where  $m$  is the expenditure multiplier;  
 $MPC$  is marginal propensity to consume;  
 $MPS$  is marginal propensity to save.

As aggregate demand equals aggregate supply in the conditions of general equilibrium, then:

$$\frac{1}{MPS} \cdot \Delta I = a \cdot I,$$

$$\text{or } \frac{\Delta I}{I} = a \cdot s'. \quad (10.16)$$

Therefore, in Domar's view, only accumulation of capital provides general macroeconomic equilibrium ( $AD = AS$ ). To meet this key economic goal, the government must either impact on the household saving or try to increase capital productivity.

The Keynesian theory of economic growth was further developed by R. Harrod. Harrod's growth model is based on the accelerator theory that allows us to determine how a change in real GDP results in a change in investment. In contrast to E. Domar who analyzed autonomous investment Harrod investigated induced investment. He formalized his explanations in the following formula:

$$\Delta I = v \cdot \Delta Y, \quad (10.17)$$

where  $v$  is the accelerator.

We see that R. Harrod came to conclusions similar to Domar's scientific results. For that reason, their models are often combined into a so-called Harrod – Domar model. It states that economic growth determined by marginal propensity to save and general equilibrium is stable in the long run. So it is described as:

$$\frac{\Delta Y}{Y} = \frac{s'}{k'}, \quad (10.18)$$

where  $s'$  is the marginal propensity to save;

$k'$  is the ratio between the increase of capital and the increase in real GDP.

At the same time, N. Kaldor, also a Keynesian follower, solved the problem of economic growth in another way. In Kaldor's view, the size of saving in the closed private economy is not stable, so it can increase to the level at which actual economic growth will be lower than guaranteed economic growth. From this perspective, Kaldor formulated a so-called specific saving hypothesis. According to this, saving depends on the dynamics of wages and, for this reason, must be lower than the profit rate.

### **10.3. The problems of economic growth in Ukraine**

*The modern type of economic growth* is associated with a change in its sources, with a transition to predominantly intensive growth factors. In the world, over the recent 30 – 40 years, a new quality of economic growth has been associated with an increase in its social orientation: the influx of funds into the social sphere (healthcare, science, culture) is increasing, the living standard of the population is rising, and the human life span is growing.

Intensification of economic activity can adversely affect the environment. This inevitably leads to the conclusion that when developing and introducing new equipment, it is necessary to take into account the environmental consequences of decisions made.

In the second half of the twentieth century, at first the countries that were the first to implement the achievements of the scientific and technological revolution (USA, England, France, etc.) were the leaders. Later, countries which most rapidly used already mastered new technologies in production began to develop ahead of the schedule. They are, for example, Japan and the so-called new industrial countries of the first generation (the Republic of Korea, Taiwan, Singapore, Hong Kong, China).

Currently, most countries, including Ukraine, have come to the conclusion that the economic growth of the national economy should be considered as an integral part of social development. In this regard, the following problems are of great importance: saving natural resources and protecting the environment, including the prevention of environmental abuse and disasters; increasing the susceptibility of the economy to the achievements of scientific and technical progress; introduction of resource-saving technologies; reduction of income inequality; development of the creative nature of work and the innovative potential of man, etc.

In the Ukrainian economy that showed positive dynamics from 1999 to September 2008, at the same time, there were signs of a disturbance in the macroeconomic equilibrium, since the growth was not driven by stable long-term factors. Economic growth did not result from systemic internal reforms but it was rather due to the influence of favourable short-term factors of both external and internal origin.

In 2008, Ukraine experienced a financial crisis, which entailed an economic crisis, accompanied by macroeconomic problems: a drop in production, unemployment and inflation.



The fall of the Ukrainian economy in 2009 was a logical result of the quality of economic growth in the pre-crisis period. It was mainly due to two factors. It is a rise in prices of Ukrainian export as a result of accelerating global economic growth, as well as high domestic demand, which was stimulated by soft monetary policy and a significant increase in bank lending due to foreign capital. Considering the deterioration of the economic situation in the world it is natural that the high level of vulnerability of the Ukrainian economy led to the development of a systemic economic crisis in our country. A significant decrease in production volumes occurred in all major sectors of the economy.

The welfare of the economy improved in 2010. In 2011, the Ukrainian economy continued to overcome the crisis. Real GDP grew by 5.2 % due to increased domestic demand and increased investment. This has contributed to increasing real household incomes. The insufficient pace of economic and social reforms during the post-crisis period (2010 – 2012) led to stagnation and deterioration in the standard of living of the population in 2013. In 2013, the growth of Ukrainian GDP was zero. In 2014, Ukraine faced an economic crisis, a military conflict in the East of the country and the annexation of Crimea. In 2015 this led to a sharp depreciation of UAH, inflation by more than 40 % and decrease in industrial production and domestic demand.

2017 – 2019 are characterized by low levels of real GDP, the level and quality of life of the population.

#### **10.4. Economic cycles**

Economic growth is uneven – economic activity experiences periods of recessions and booms or a decrease or increase in production.

*The economic cycle* (business cycle, business activity cycle) is ups and downs in the economy that have been constantly repeating over the years.

At the present stage of economic development, the economic cycle is considered as a temporarily synchronized deviation of the main indicators of business activity from the long-term trend of economic growth.

A trend is the result of factors that determine a long-term economic growth of business activity indicators (level of savings, technological shifts, growth in labour resources, etc.).

The cyclical fluctuations in the economy can be observed due to the analysis of the dynamics of such indicators of business activity as the growth rate of GDP, the general price level, the level of capacity utilization.

The most famous economic cycles include the following types:

1. *Short-term economic cycles* (J. Kitchin's cycles, small cycles, stock cycles) last from 1 to 4 years. The reason for short-term economic cycles is the change in the world gold reserves, uneven reproduction of the working capital, changes in monetary circulation.

2. *Medium-term economic cycles* (the cycles of C. Juglar, K. Marx and industrial cycles) last for 7 – 11 years. The reason for the cycles is the need to update the active part of fixed assets.

3. *Long-term (long waves)* economic cycles of N. Kondratiev last for 48 – 66 years. The reasons for the cycle are periodic changes in basic technologies, energy sources, updating facilities and infrastructure.

Let's consider in more detail the main phases of a medium-term economic cycle. It should be kept in mind that the classical cycle of business activity has four phases and the modern cycle has two phases. Classical economic (business) cycles were inherent in the economy of the 19th century.

Schematically, the classical cycle of business activity is shown in Fig. 10.4.

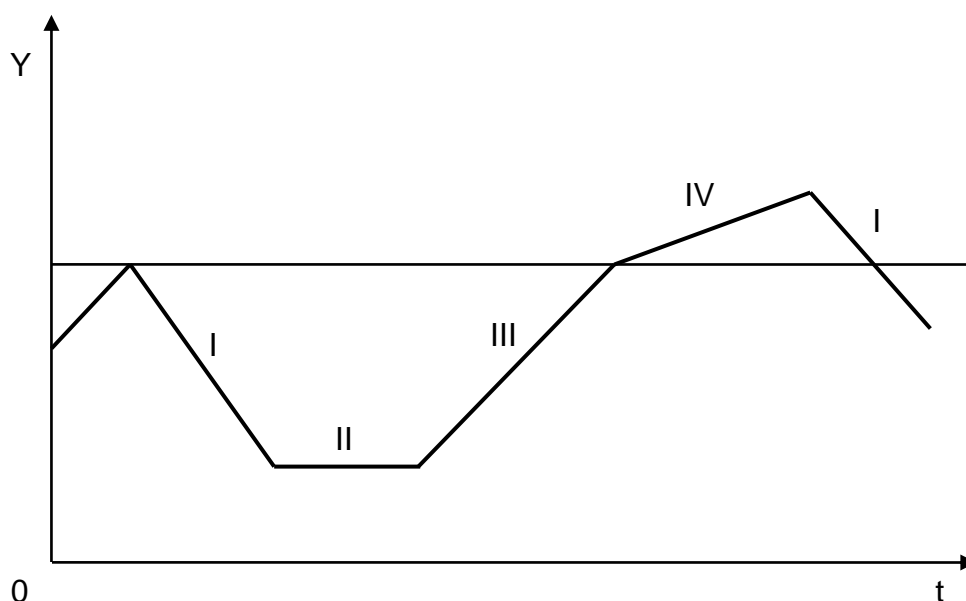

Fig. 10.4. **The diagram of the classical cycle of business activity**  
(I is crisis, II is depression, III is recovery, IV is rise)

A crisis begins if the mass of unsold products increases due to the relative overproduction of goods. Credit from banks decreases, the loan interest rate rises which leads to a decrease in the profit of enterprises and banks, a

decrease in the stock price, and depreciation of capital. The stocks of finished goods increase, the unemployment rate increases, etc.

In the phase of depression, production no longer decreases, a sharp drop in prices stops, stocks and loan interest rate decrease.

The phases of revitalization and recovery have common features. The difference between them is that in the recovery phase, the economy reaches the level of the pre-crisis state and in the revitalization phase it exceeds it.

In the recovery and revitalization phases, there is an increase in production, in general level of prices, the level of income of the population but the level of unemployment and stocks decreases. Economic growth in the boom phase continues until production again exceeds solvent demand and a new economic cycle begins (the crisis phase).

*Modern economic cycles* of the 20th and 21st centuries were modified due to the changes in the technological mode of production and government intervention in the economy (Fig. 10.5).

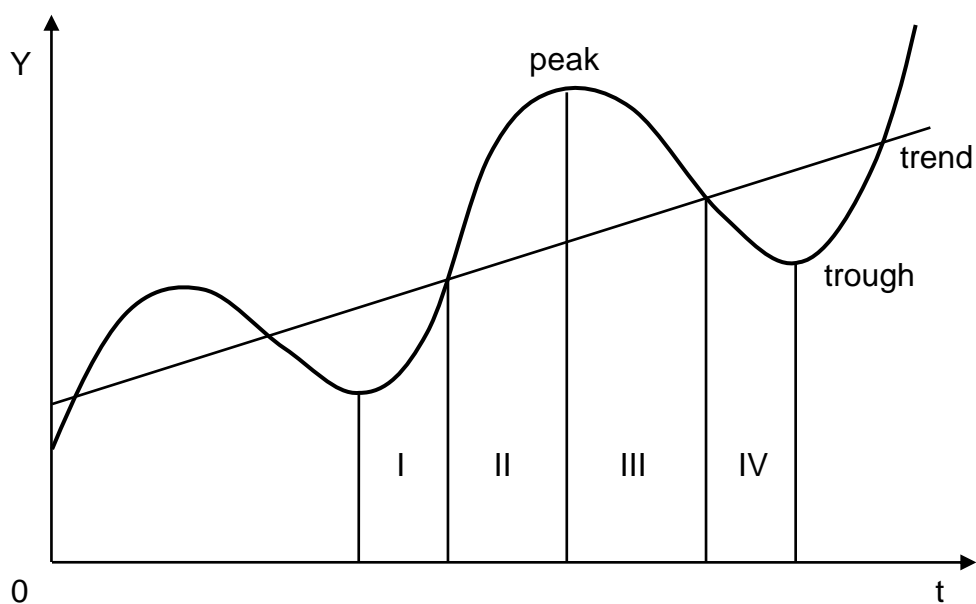

**Fig. 10.5. The scheme of the modern economic (business) cycle**  
(I – II is rise, III – IV is decline)

The recession phase, dependently on its duration, is called a decline – if its duration does not exceed 6 months; a recession – if its duration is 6 months to 1 year; a depression – if its duration is more than 1 year.

The feature of the modern economic cycles is that, firstly, in the second half of the 20th century, as a result of the actions of the government and the

monopoly sector in the crisis phase, prices did not drop as in the classical cycle, but on the contrary, they rose. This phenomenon was called *stagflation* and it was of great importance since it violated the mechanism of self-regulation of the economy and sharply increased the role of the government in conducting anti-crisis and anti-cyclical policies. Secondly, in the anti-crisis policy, the policy of the central bank regarding the level of the interest rate is changing – it tends to decrease, that is, the "cheap money" policy is being implemented. Thirdly, modern economic cycles differ in duration: there is a reduction in the recession phase and an increase in the duration of the recovery phase, etc.

There are more than 200 theories that explain the causes of economic cycles.

All theories from the point of view of determining the factors that cause economic cycles can be divided into: exogenous theories (external), according to which the causes of economic cycles lie outside the framework of the economic system (population dynamics, the impact of scientific and technological progress, natural and social disasters, the discovery of new natural resources, gold, land etc.); endogenous (internal) theories that consider the causes of economic cycles in the influence of factors of the economic system itself (consumption, investment).

According to other theories, the main problems of economic cycles lie in the mechanism of the multiplier – accelerator. In accordance with this model, the growth of autonomous investments leads to a multiplicative increase in income that in turn leads to an increase in the demand for consumer goods and growth of production of goods, that is, to an increase in investments. The growth of such induced investments is accelerative dependently on income growth. The growth of these investments leads again to the multiplicative process, etc.

## Glossary

**Socio-economic development** is the process of continuous change in the material basis of production as well as in the totality of diverse relationships between economic entities and social groups of the population.

**Economic growth** is a long-term sustainable development of the economy, that is, the process of a gradual increase in national income and

gross domestic product in the long-term period without disturbing the equilibrium in the short-term periods.

**Extensive (or quantitative) economic growth** means an increase in real GDP based on the increase in the quantity of production factors.

**Intensive (or qualitative) economic growth** means an increase in real GDP based on the increase in the quality of production factors.

**Human Development Index** is an integral indicator used to estimate the level of economic, social, educational and cultural development of the country. It varies from 0 to 1 and includes three partial indicators: GDP, education index, longevity index.

**Production function** describes quantitative relationship between the size of resources and the increase in their productivity.

**Economic cycle** (business cycle, business activity cycle) is ups and downs in the economy that have been constantly repeating over the years.

**Boom (or expansion)** is the phase of the economic cycle when real GDP, the number of the employed, incomes and profits sharply rise.

**Peak** is the phase of the economic cycle that marks the end of the boom and the beginning of decline in real GDP.

**Recession** is the phase of the economic cycle when real GDP, the number of the employed, incomes and profits sharply drop. That downturn usually lasts from six to ten months and is marked by a widespread contraction of business activities in most sectors of the economy.

**Trough** is the phase of the economic cycle that marks the end of the contraction and beginning of the increase in real GDP.

### Examples of heuristic problems with solutions

**Problem 1.** The government of the country B has tasked economic consultants to forecast the GDP growth in the next year. The leading economists have estimated that consumer spending will amount to 62.5 % of GDP, the investment and government spending will reach 1.5 billion monetary units, net exports will be 0. Determine what forecast the economic consultants have given regarding the possible GDP in the next year.

*Solution.* For the country with the open economy:  $Y = C + I + G + X_n$ .

Substitute the data:  $Y = 0.625Y + 1.5 + 0$ ;  $Y = 4$ .

Answer: next year GDP is going to be 4 billion monetary units.

**Problem 2.** The population growth rate is 3 %, the depreciation rate is 4 %, and the marginal productivity of capital is 9.5 %. What should the pace of technological progress be for the given parameters in order to comply with the golden rule of accumulation?

*Solution.* Use the formula:  $MP_k = \delta + n + g$ ;  
 $g = MP_k - (\delta + n)$ ;  $g = 9.5 \% - (4 \% + 3 \%)$ ;  $g = 2.5 \%$ .

Answer: the pace of technological progress for the given parameters should be equal to 2.5 %.

### Questions for self-assessment

1. What is the economic growth? How can it be measured?
2. Provide definitions of economic development and economic growth. Are these definitions identical?
3. Illustrate economic growth with the help of a production curve.
4. Describe the main factors of economic growth.
5. Name the types of economic growth.
6. Identify the main problems of economic growth.
7. Define the main sources of endogenous economic growth. What is the most important one among them in the Ukrainian economy?
8. Explain the Cobb – Douglas production function.
9. What does the "accumulation gold rule" show? Why should the government use it in the free market economy?
10. Describe the neo-Keynesian theory of economic growth and explain its weaknesses. Give at least two examples of Keynesian growth models.
11. Identify the pros and cons of Solow's economic growth model. What does it mean for modern models?
12. What is the essence of the business cycle? What are the causes of economic (business) cycles?
13. What are modern business cycles? How do they differ from classical ones?
14. What do you know about the Kondratiev long waves? Give at least three examples of Kondratiev long waves in the world economic history during the 19th – 21st centuries.

## Review questions

1. In 2014, Andrii Illarionov, the American analyst, advised Ukraine to eurolize, that is, to eliminate the hryvnia and use the E.U. euro as its currency. Discuss how eurolization might have prevented financial crisis in the Ukrainian banking system in 2015 – 2016.

2. Explain the International Monetary Fund's (IMF) role in the financial crises of post-socialist economies.

3. What could E.U. policymakers have done to prevent the 2008 World Financial crisis or at least reduce its severity among European countries? Define: a) how might the E.U. government have prevented the stock market crash and bank panics that started the financial crisis; b) what could Ukrainian policymakers have done to dampen the effects on the national economy.

4. Based on the newest Ukrainian economic history, prove the relationship between political elections and business cycles.

## Tests

1. Economic growth is:

- a) an increase in the nominal volume of GDP in a certain period of time;
- b) an increase in the real volume of GDP in absolute terms in a certain period of time;
- c) an increase in the real volume of GDP per capita in a certain period of time;
- d) answer a) and c).

2. In the "AD – AS" model of economic equilibrium, economic growth can be represented as:

- a) a shift of the AS curve to the left;
- b) a shift of the curve AD to the right;
- c) a shift of the curve AD to the left;
- d) a shift of the curve AS to the right.

3. The extensive factor of economic growth is not:

- a) an increase in capital investment;
- b) an increase in human productivity;
- c) an increase in capital productivity;
- d) an increase in natural resources.

4. Neoclassical growth models is(are):

- a) Solow growth model;

- b) Mid growth model;
- c) Cobb – Douglas production function;
- d) both a) and c).

5. The Cobb – Douglas production function is:

- a) a one-factor production model;
- b) a two-factor production model;
- c) a three-factor production model;
- d) the right answer is not given.

6. The most significant reason for economic growth in developed countries is:

- a) the growth of skilled labour;
- b) an increase in the volume of working time;
- c) technological changes in production;
- d) an increase in the volume of capital.

7. If the volume of GDP grows faster than the population, then:

- a) the volume of GDP per capita decreases;
- b) the volume of GDP per capita increases;
- c) the volume of GDP per capita does not change;
- d) the volume of GDP per capita and the population are not connected.

8. During the recession period, the most declining factor(s) is(are):

- a) consumer spending on medicine;
- b) salary level;
- c) corporate profits;
- d) government procurement of goods and services.

9. The peak is a phase of the business cycle:

- a) when real output is increasing;
- b) when real output is falling;
- c) which marks the end of expansion and the beginning of contraction;
- d) which marks the end of contraction and the beginning of expansion.

10. Exogenous shocks are caused by the following:

- a) commodity price fluctuations;
- b) shortages in natural resources, namely energy;
- c) flight of foreign capital;
- d) all the above mentioned.

Answers: 1d; 2d; 3d; 4d; 5b; 6b; 7b; 8b; 9c; 10d.



## 11. The state in the system of macroeconomic regulation

A market economy cannot exist and function without government regulation. Uncontrolled market processes are destructive to society and nature. Therefore, a market economy needs regulation more than any other.

Government regulation is a system of standard measures of a legislative, executive and supervisory nature implemented by competent state institutions. The general strategy of government regulation of a market economy is based on relevant principles. Firstly, the state should finance only those sectors that do not attract private business. Secondly, state-owned enterprises should not compete, but rather help to develop private businesses. Thirdly, government fiscal, credit, and tax policies should foster economic growth. Fourthly, government intervention in market processes is as more effective as more market-oriented form it takes.

11.1 The role of the state in the economy and the basic functions of the state.

11.2. The nature of fiscal policy of the state.

11.3. The nature of monetary policy of the state.

**Key terms:** state, state regulation, macroeconomic policy, state economic functions, monetary policy, money circulation, interest rate, fiscal policy, built-in stabilizers, discrete policy, automatic fiscal policy, state budget, state budget deficit, state budget excess, state crisis budget.

### 11.1. The role of the state in the economy and the basic functions of the state

*The state regulation of the economy* is purposeful activity of the state to create legal, economic and social prerequisites necessary for the most effective functioning of the market mechanism and minimization of its negative consequences.

At present, the state performs *three main functions*:

1. *Ensuring production efficiency.* It consists in the fact that the state establishes taxes and privileges, regulates monetary circulation and the credit

system and creates conditions for the efficient use of limited resources. The state acts: as an investor, making state investments in the development of the economy; as a seller and buyer, purchasing goods and services from private enterprises in accordance with state orders and state contracts.

2. *Ensuring justice.* The government introduces the tax policy that redistributes income in society and provides funding for social programs to help the poor, the unemployed and the disabled members of society.

The state influences the process of reproduction of the labour force, creating a state system of education, healthcare, training and retraining of workers.

3. *Ensuring stability, eliminating excessive downturns and "overheating" in the economy.* The state actively uses modern methods of programming and forecasting the economy, countercyclical policies to reduce the depth of economic decline, the duration of business cycles to accelerate the exit from the crisis phase.

The guidelines, that the state follows in the process of regulation of the economy, are indicators that characterize the level of economic development and the quality of life: human life span; income (gross domestic product) per capita; level of employment; degree of realization of human rights; environmental conditions, etc.

In economic science, there are *two main approaches to state participation in the regulation of economic processes*:

- classical theory, based on the fact that the market mechanism automatically ensures equal supply and demand and, thus, makes impossible long-term disruptions in the economy, in particular the decline in production, inflation, unemployment. Therefore, the role of the state in regulating the economy should be minimal;

- Keynesian theory which considers that the state should actively intervene in the regulation of the economy.

## **11.2. The nature of fiscal policy of the state**

The government, in order to stabilize the economy, changes the amount of income or expenditures of the state budget, which are measures of fiscal (from the Latin *fiscalis* – official) policy.

*Fiscal (budgetary-tax) policy* is a combination of forms and means of state influence on the economy through taxation, forming the volume and structure of public spending in order to ensure the proper level of employment, preventing and limiting inflation and the harmful effects of cyclical fluctuations.

*The goals* of fiscal policy are: stable economic growth, full employment of resources, stable price level, balanced budget.

*Fiscal policy instruments* are government procurement of goods and services, taxes, transfers. They affect both aggregate demand (AD) and aggregate supply (AS).

Depending on the phase of the country's economy cycle, a stimulating (expansionary) or restraining (restrictive) fiscal policy is applied.

*Stimulating (expansionary) fiscal policy* is applied during a recession (Fig. 11.1). It aims to increase business activity and it is used as a means of combating unemployment.

The instruments for stimulating fiscal policy are: increasing public procurement, tax cuts, increase in transfers.

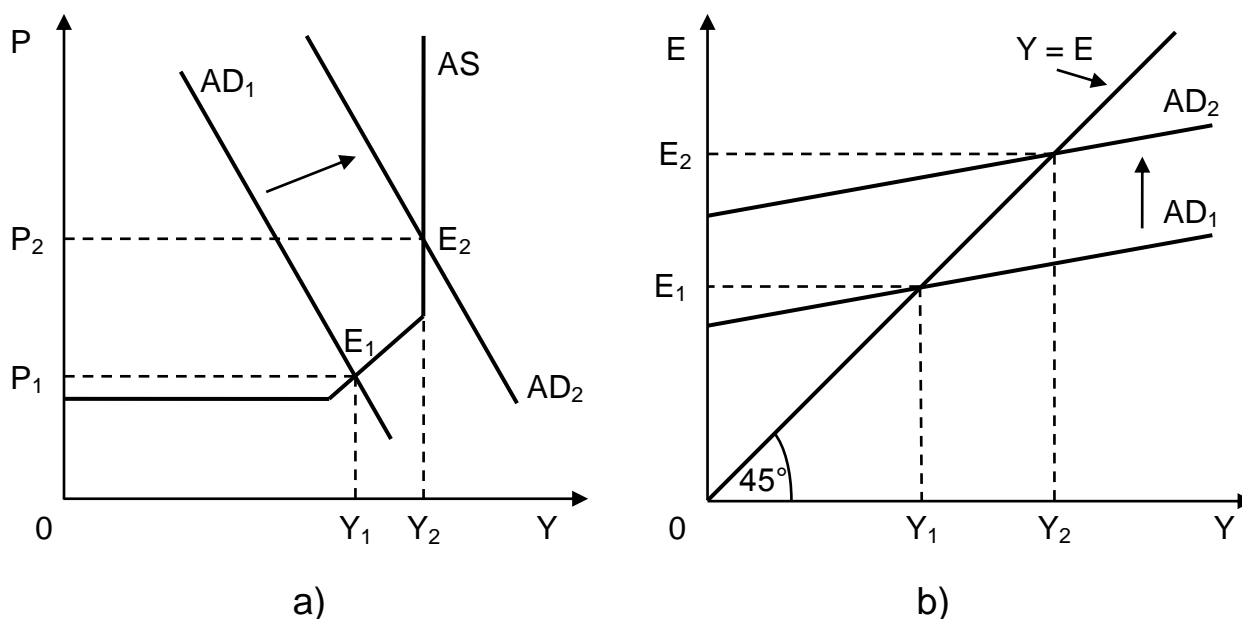

**Fig. 11.1. A change in the balance in the AD – AS (a) and Keynesian cross (b) models as a result of the stimulating fiscal policy**

The stimulating (expansionary) fiscal policy is aimed at the overcoming of the economic crisis, stimulation of the growth of production and employment

and is associated with an increase in government spending and a reduction in taxes and, thus, implies the stimulation of total costs. In the AD – AS model (Fig. 11.1a), the implementation of the stimulating fiscal policy will be reflected in a shift of the  $AD_1$  curve to the right to  $AD_2$  (respectively, in an increase in the equilibrium output from  $Y_1$  to  $Y_2$  and an increase in the price level from  $P_1$  to  $P_2$ ), and in the Keynesian cross model – in the shift of the curve of total expenditures  $AD_1$  up to  $AD_2$  (Fig. 11.1b).

In the long run, tax cuts will increase the supply of the production factors and increase the economic potential, which will be displayed in the AD – AS model by moving the AS curve to the right.

Restraining (restriction) fiscal policy (Fig. 11.2) is used during too fast development of the economy ("overheating" of the economy). It aims to refrain business activity in order to fight inflation.

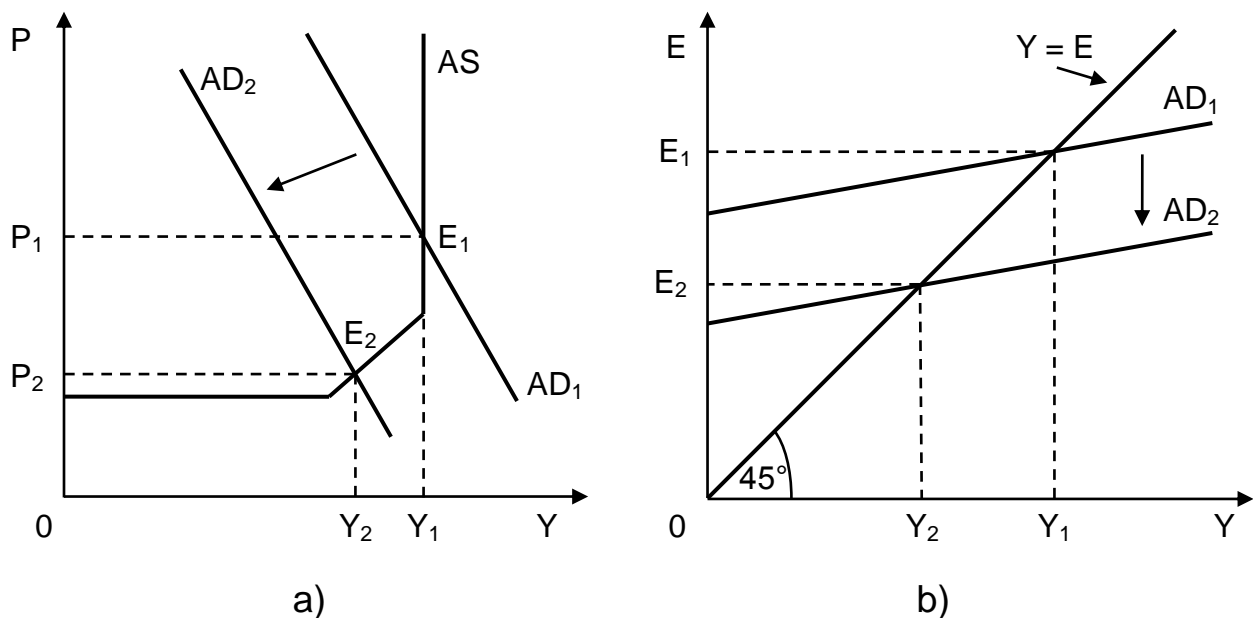

**Fig. 11.2. The change in the equilibrium in the models AD – AS (a) and the Keynesian cross (b) as a result of the restraining fiscal policy**

The instruments of the restraining fiscal policy are: reduction in public procurement; tax increase; reduction of transfers.

*Restraining (restrictive) fiscal policy* is aimed at the limiting of the cyclical increase and is associated with the increase in taxes and a decrease in government spending and, thus, with the reduction in total spending. These measures are reflected in the AD – AS model in the shift of the  $AD_1$  curve to

the left to  $AD_2$ , a change in the equilibrium output level from  $Y_1$  to  $Y_2$  and the price level from  $P_1$  to  $P_2$  (Fig. 11.2a), and in the Keynesian cross model (Fig. 11.2b) – the curve of total costs  $AD_1$  down to  $AD_2$ .

In the short term, these measures are designed to reduce demand inflation by increasing unemployment and declining production. In the long term, fiscal restriction measures can cause stagflation, that is, an increase in prices against the background of a decline in production and an increase in unemployment (there is a shift in the aggregate supply curve  $AS$  to the left).

In addition, depending on the method of influence of the fiscal policy instruments on the economy, discretionary and automatic fiscal policies are distinguished.

Discretionary (from the Latin *discrecio* – discretionary) fiscal policy is a policy in the field of government spending and taxation. The instruments of discretionary fiscal policy are government procurement, taxes and transfers.

*The impact of public procurement on GDP.* According to the equilibrium GDP equation, an increase, for example, in public procurement means an increase in autonomous costs. As shown in Fig. 11.3, increasing public procurement by  $\Delta G$ , the total expenditure curve by the same amount moves up from position  $E_1$  to position  $E_2$ . As a result, the equilibrium in the economy moves from point  $A_1$  to point  $A_2$ , and GDP increases from  $Y_1$  to  $Y_2$ .

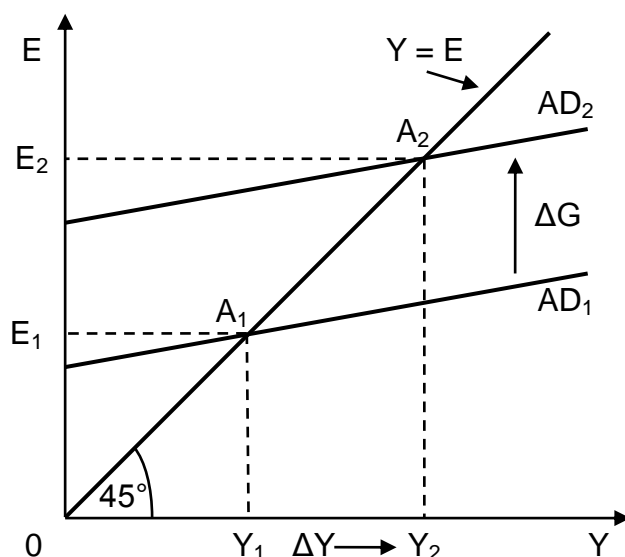

**Fig. 11.3. The impact of public procurement on GDP in the Keynesian cross model**

Wherein, the value of GDP growth is greater than the growth of public procurement, that is,  $\Delta Y > \Delta G$ , which indicates that public procurement affects the GDP multiplicatively, and the ratio  $\Delta Y/\Delta G$  is a cost multiplier. It shows how much GDP (Y) changes with a change in government spending (G) per unit.

Thus, we obtain the formula for the cost multiplier ( $m_G$ ) in a mixed economy:

$$m_G = \frac{\Delta Y}{\Delta G}, \quad (11.1)$$

or

$$m_G = \frac{1}{1 - MPC} \quad (11.2)$$

or

$$m_G = \frac{1}{1 - MPC(1 - t)}, \quad (11.3)$$

where  $t$  is the marginal tax rate;

$MPC(c')$  is the marginal propensity to consume.

The impact of public procurement on GDP can be expressed using the formula:

$$\Delta Y = \Delta G \cdot m_G. \quad (11.4)$$

Net taxes are defined as the difference between gross taxes and transfer payments. That is, net taxes are directly dependent on gross taxes and inversely – on transfers. The dependence of net taxes on income can be determined using the formula:

$$T_r = t \cdot Y, \quad (11.5)$$

where  $T_r$  is net taxes.

Moreover, net taxes can change not only discretionarily, but also automatically. Graphically, the consequences of such a fiscal policy are presented in Fig. 11.4.

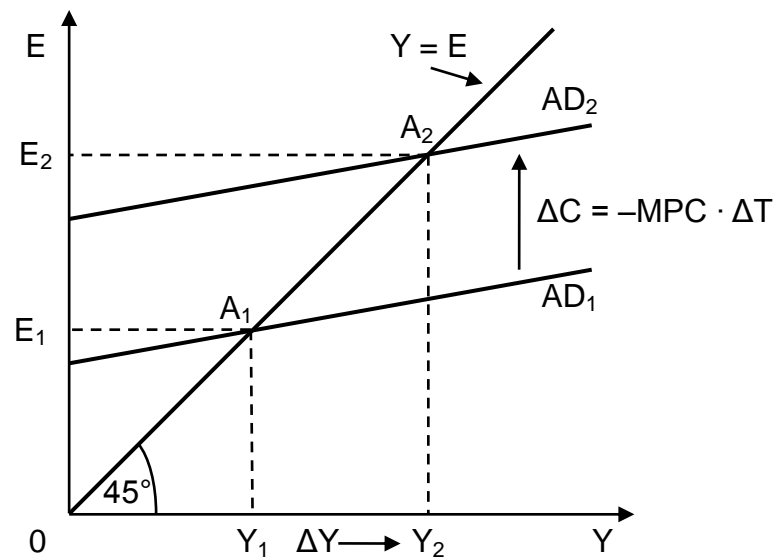

Fig. 11.4. The net tax reduction in the Keynesian cross model

As Fig. 11.4 shows, the line of total expenditures moves upward by the distance that equals the increase in autonomous expenditure on consumption ( $\Delta c$ ) and the economic equilibrium – from point  $A_1$  to point  $A_2$ . Moreover, the increase in income ( $\Delta Y$ ) exceeds the increase in autonomous consumption costs due to the occurrence of additional consumption costs induced by income growth. There is an inverse relationship between the change in the equilibrium GDP and the discretionary change in net taxes, which is also called *tax multiplier*. It is less than the *expenditure multiplier* in proportion to marginal propensity to consume:

$$m_T = \frac{\Delta Y}{\Delta T}, \quad (11.6)$$

or

$$m_T = \frac{-MPC}{1-MPC}, \quad (11.7)$$

or

$$m_T = \frac{MPC}{1-MPC(1-t)}. \quad (11.8)$$

The effect of the net taxes on GDP can be determined using the formula:

$$\Delta Y = -\Delta T \cdot m_T. \quad (11.9)$$

The sign "-" indicates that for GDP growth it is necessary to reduce taxes.

In addition to the autonomous use of fiscal instruments, the state can use them simultaneously. But besides GDP, discretionary fiscal policy also affects the state budget. At the same time, public procurement and transfers affect the state budget expenditures, and taxes influence its revenues. A defining feature of a balanced fiscal policy option is that it generates a balanced budget multiplier. *The balanced budget multiplier ( $m_B$ )* is defined as the ratio between the increase in GDP (as a result) and the increase in the state budget (as a reason) and has the form:

$$m_B = \frac{\Delta Y}{\Delta B}, \quad (11.10)$$

or 
$$m_B = m_G - m_T. \quad (11.11)$$

*Non-discretionary (automatic) fiscal policy* is based on the facilities of fiscal instruments, which are part of net taxes, to change automatically, that is, without the direct participation of the state, since it is based on the action of built-in stabilizers of the economy. This is due to the fact that taxes and transfers depend on the income and therefore can vary proportionally to changes in GDP even with stable tax rates and a constant level of transfer payments.

*Built-in stabilizers of the economy* are an economic mechanism that automatically responds to changes in economic conditions.

*Built-in stabilizers of the economy* support economic stability through self-regulation. The built-in stabilizers of the economy are: progressive income tax, unemployment benefits, poverty benefits, subsidies to farmers, as well as a profit sharing system.

Non-discretionary (automatic) fiscal policy, changing taxes and transfers, affects the efficiency to perform the stabilization function in the economy in an automatic mode.

In many countries, as the world experience of the 1980's shows, reduction of corporate income taxes creates additional conditions for development and increases interest in strengthening the economy.

The famous American economist Arthur Laffer in the late 70s of the 20th century developed a model. It was called the Laffer curve which



substantiated the relationship between the budget revenues from taxes and tax rates (Fig. 11.5).

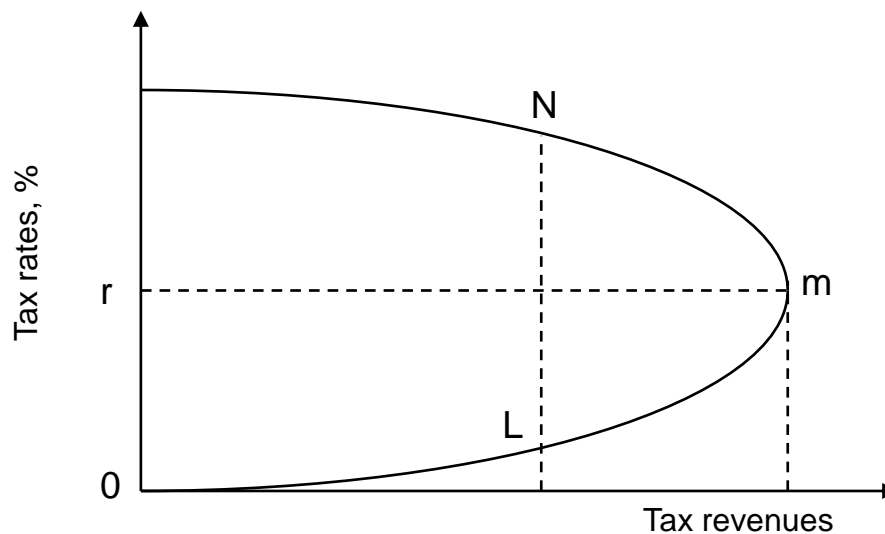

Fig. 11.5. **The Laffer curve**

As Fig. 11.5 shows, an increase in the tax rates from 0 to  $r$  will provide an increase in budget revenues. They reach a peak at the point  $m$  on the curve. A further increase in tax rates will lead to a decrease in incentives for further development of production, as a result, the amount of taxable income will decrease to the level that reduces the amount of tax revenues to the budget.

Assessing the impact of fiscal policy on the economy, it is necessary to take into account that its measures are directly or indirectly related to the state budget. Any changes in fiscal policy are accompanied by corresponding changes in the state budget.

The state of the country's budget depends on both discretionary measures of fiscal policy and the phase of the economic cycle.

*The actual budget* displays the actual revenues received and expenses incurred. The full-time budget (structural budget) is a conditional budget in which revenues and expenditures are determined on the basis of the assumption that the economy operates in full-time employment, that is, with unemployment equal to the natural norm, and production equal to potential GDP.

The biggest problem for fiscal policy is *budget deficits*, which are defined as the difference between net taxes and public procurement.

Thus, *the actual deficit* is the excess of government expenditures over its revenues. *Structural deficit* is the excess of government spending over its

income in full employment. A *cyclical deficit* is the difference between actual and structural budget deficits.

### 11.3. The nature of monetary policy of the state

*Monetary policy* or monetary and credit policy is a set of measures in the field of monetary circulation and credit aimed at the regulation of economic growth, stabilization of prices and ensuring the stability of the country's monetary unit, ensuring employment and levelling the balance of payments.

The role of monetary policy is determined by its goals and instruments. The objectives of monetary policy are divided between the *final* (main, strategic) and *intermediate* (auxiliary, tactical) goals. The ultimate goals of monetary policy are an increase in real GDP, reduction in unemployment and a decrease in inflation.

*Intermediate goals* include money supply, interest rate, lending volume, exchange rate, debt level, etc.

*Monetary policy instruments* are specific actions of the Central Bank aiming to change the mass of money and the interest rate.

All instruments of monetary regulation of the economy can be divided into two groups: instruments of indirect influence and instruments of direct influence (Table).

Table

#### The instruments of monetary regulation of the economy

Indirect regulation	Direct regulation
Open market operations; regulating the quota of reserve requirements; interest rate policy (setting the discount rate); refinancing of commercial banks; regulating the rate of national currency	Establishing direct restrictions on implementing cash transactions; introducing direct restrictions on the Central Bank lending to commercial banks; establishing restrictions or a ban on direct lending by the central bank to the budget needs; direct distribution of credit resources that are provided to commercial banks through refinancing, between priority areas, industries, regions

Let's consider the mechanism of indirect regulation in more detail.

*Open market operations.* Their nature is in the fact that when buying securities on the market, the Central Bank additionally directs the appropriate amount of money into circulation and this increases, first, bank reserves and, second, the total mass of credit money. Selling securities from its portfolio, it withdraws bank reserves in the corresponding amount. It means that the total mass of money in circulation also decreases.

As a result of these operations, money supply on the market accordingly increases or decreases, which ultimately affects the situation on commodity markets.

Regulatory effect can be achieved by the sale-purchase of any securities on the open market. However, Central Banks are generally limited to operations with government securities.

*Regulation of reserve requirements.* The mechanism of this tool is that the Central Bank establishes, for all banks and other depository institutions, the rate of mandatory storage of borrowed funds on correspondent accounts without the right to use them and without paying interest rates on them.

By increasing the required reserve ratio, the Central Bank reduces the amount of excess reserves of banks, reduces their credit capacity, and reduces the level of multiplication of deposits. Accordingly, the total amount of money supply decreases.

By lowering the required reserve ratio, the Central Bank increases the money supply. The situation changes in a contrary way – the volume of free reserves increases, the credit capacity of banks and the level of multiplication of deposits increases.

The advantage of this monetary policy tool is that it affects all banks equally, changing the money supply immediately and strongly enough.

*Interest rate policy or setting up interest rates.* The essence of this mechanism is that the Central Bank sets up interest rates on loans that it provides to commercial banks in the order of their refinancing. For Ukraine, the interest rate of the Central Bank is the NBU discount rate.

By increasing the level of the discount rate, the Central Bank restrains the demand of commercial banks for its loans, slows down the growth of their excess reserves and bank lending to economic entities and restrains the multiplication of deposits and the growth of money supply.

The decrease in the discount rate by the Central Bank has opposite consequences – it increases the demand of commercial banks for loans and their excess reserves, which leads to an increase in money supply.

Interest rate policy as a monetary instrument has certain disadvantages. Its influence on the money supply is not clear enough and hardly efficient. For commercial banks and other economic entities, it is important not only to change the discount rate but to change its ratio with market interest rates used to receive loans from other lenders and provide loans themselves.

*Refinancing of commercial banks* is a tool that is used in conjunction with interest rate policy. In addition to changing the discount rate, the Central Bank can regulate the demand for its loans from commercial banks by changing other conditions to provide these loans – changing their range, restricting the purpose, limiting the volume of individual loans, etc.

*Regulation of the national currency.* The tool is a very clear, efficient and powerful action. By the nature of its influence on the mass of money, it is similar to the operations of the Central Bank in the open market.

If the Central Bank plans to reduce the amount of money in circulation, it is enough to sell the corresponding mass of foreign currency on the market. It leads to reduction in bank reserves and money supply. And vice versa, if it is necessary to increase the mass of money in circulation, the Central Bank needs to buy the corresponding mass of foreign currency. These operations are called *foreign exchange intervention*. Although the immediate goal of these operations is to regulate the national currency, they indirectly affect its mass in circulation.

The monetary policy of the National Bank is implemented through a policy of cheap or expensive money.

*The policy of cheap and expensive money.* If the Central Bank sells government securities, then, as a result, securities are concentrated in commercial banks, non-financial firms, as well as among the population, and money is concentrated in the Central Bank. This reduces bank reserves and commercial banks' capability to lend. A reduction in reserves in commercial banks leads to the reduction in money supply, because of this the interest rate on loans and deposits increases, and investments decrease. This is the so-called expensive money policy, which is one of the elements of government restraining (restrictive) policy.

If the government, pursuing a policy of stimulation (expansion), wants to intensify the development of the economy and reduce the existing unemployment

rate, then in order to achieve its goal it is necessary to increase the money supply. The Central Bank carries out the following activities. It buys government securities from commercial banks, non-financial firms, and the public, thus increasing the reserves of commercial banks and their capability to lend. It lowers the required reserves ratio, while a part of the required reserves is converted into excess reserves and the size of the money multiplier increases. It reduces the level of the discount rate, and makes possible expanding of the reserves of commercial banks through borrowing from the Central Bank. As a result of the combination of all these actions, a loan becomes cheaper, more affordable. This is the so-called cheap money policy.

Fiscal and monetary measures can be applied simultaneously to increase the effectiveness of the policy in practice.

## **Glossary**

**Actual deficit** is the excess of government expenditures over its revenues.

**Balanced budget multiplier** is the ratio between the increase in GDP (as a result) and the increase in the state budget.

**Built-in stabilizers** are an economic mechanism that automatically responds to changes in economic conditions.

**Fiscal policy** is a combination of forms and means of state influence on the economy through taxation, forming the volume and structure of public spending in order to ensure the proper level of employment, preventing and limiting inflation and the harmful effects of cyclical fluctuations.

**Laffer curve** is a curve that shows the relationship between the budget revenues from taxes and tax rates.

**Net taxes** are defined as the difference between gross taxes and transfer payments.

**Structural deficit** is the excess of government spending over its income in full employment.

**Tax multiplier** is an inverse relationship between the change in the equilibrium GDP and the discretionary change in net taxes.

## Problems with examples of solutions

**Problem 1.** The value of the required reserve ratio is 0.25. The volume of deposits is twice greater than the amount of cash. Calculate the money multiplier, taking into account the cash.

*Solution.* According to the money multiplier formula, as the ratio of the money supply to the monetary base, where C is the amount of cash, D is the volume of deposits, R is the volume of reserves, cr is the deposit ratio, rr is the required reserve ratio, first in a general way, then by substituting the value of the given data we get:

$$M = \frac{C+D}{C+R} = \frac{C/D+1}{C/D+rr} = \frac{cr+1}{cr+rr} = \frac{C/2C+1}{C/2C+1/4} = \frac{1/2+1}{1/2+1/4} = 1.5/0.75 = 2.$$

**Problem 2.** Last year the actual GDP of a country was €3,800 billion. For the current year, the government has planned an increase in GDP to €4,300 billion in order to reach its equilibrium potential value. In recent years, the marginal propensity to consume in the country has been 0.78. By how much is it necessary to increase government spending or reduce taxes for the economy to reach an equilibrium state?

*Solution.* The value by which it is necessary to increase government spending is determined by the formula of the multiplier of government spending:

$$\Delta G = \frac{\Delta Y}{m_g} = \frac{4\,300 - 3\,800}{1/(1-0.78)} = \frac{500}{4.54} = 110.13 \text{ bln euros.}$$

The value by which it is necessary to reduce taxes in order to achieve an equilibrium state is determined by the formula of the tax multiplier:

$$\Delta T = -\frac{\Delta Y}{m_t} = -\frac{\Delta Y}{c'/(1-c')} = -\frac{500}{0.78/(1-0.78)} = -141.24 \text{ bln euros.}$$

## Questions for self-assessment

1. What are the main economic functions of the state?
2. What are the causes of government intervention into the market economy?
3. What is the state regulation of the economy?
4. Name the tools of state regulation of the economy.
5. Define the volumes and objectives of macroeconomic regulation.
6. Why is, with state intervention, the modern economy called mixed?
7. What are the types of fiscal policy?
8. What can be the subject of taxation?
9. What is the nature and imperfection of the Laffer curve?
10. What are the main groups of taxes?

## Review questions

1. What are the causes of government intervention in the market economy?
2. What are the main Keynesian arguments about the need for state intervention in the economy?
3. What processes occur in the national economy if the equilibrium on the money market is disturbed?
4. What is the difference between the governing and regulatory functions of the credit system?
5. How does the interest rate affect the level of investment demand?
6. Describe the multipliers of taxes and expenses.
7. What is the effect of the built-in stabilizers of the economy? Give examples.
7. Define the state budget.
8. What are the types of budget deficits?
9. Describe the monetary regulation of the economy.
10. Describe the main types of monetary policy.

## Practical tasks

1. In 2016, the money deposit ratio was 10 %, the actual reserve ratio was 30 %, and the monetary base was 200 million monetary units. In 2018, the money deposit ratio was 20 %, the actual reserve ratio did not change, and the monetary base increased by 50 million monetary units. If the money multiplier mechanism controls the money supply, how has it changed over this period?

2. Assume that public procurement is 500 monetary units, the tax function has the form  $T = 0.4U$ ; the transfer function  $F = 0.2U$ ; the price level  $P = 1$ . Government debt  $D = 1\,000$  monetary units at an interest rate of  $R = 0.1$ . Actual output is 2 000 monetary units, and potential output amounts to 2 500 monetary units. Determine: a) the balance of the state budget; b) the size of the structural deficit of the state budget; c) the magnitude of the cyclical deficit of the state budget.

3. The national economy is described by the following data:

$$C = 160 + 0.8(Y - T); \quad I = 100 - 500r; \quad M_d = (0.5Y - 50/r)P.$$

Government spending amounts to 400 monetary units, nominal money supply is 600 monetary units, the price level is  $P = 1$ , and taxes are  $T = 200$  monetary units. Determine the equilibrium interest rate  $r$  and the income level  $Y$ .

4. Cash receipts to commercial bank No.1 amount to 1 000 UAH, with a required reserve ratio of 0.2; the cash ratio is 0.25. Determine what the increase in cash and borrowed resources is equal to.

## Heuristic tasks

1. The state budget combines public procurement of goods and services and transfer payments into a general category of government spending. Why, when choosing fiscal policy instruments, is it necessary to distinguish between public procurement and transfers?

2. Explain the statement: "With the right combination of fiscal and monetary policies, you can simultaneously reduce unemployment and suppress inflation, and ensure economic growth". Justify the answer.

3. Can the current budget surplus always serve as the basis for decision making regarding future economic policies? Can a budget surplus serve as such basis in full employment?



## Tests

1. The state regulates the market with the help of:

- a) taxation;
- b) investments;
- c) subsidies;
- d) all answers are correct.

2. The effect of the multiplier of government spending and the effect of the multiplier of taxes accompany:

- a) monetary and credit policy of the state;
- b) fiscal policy of the state;
- c) state trade policy;
- d) international policy of the state.

3. The state conducts the policy of cheap money when the following is observed in the country's economy:

- a) economic growth;
- b) crisis and unemployment;
- c) peak, because during this period the economy needs a lot of money;
- d) low average salary.

4. If the National Bank buys a large number of government securities from the population, then:

- a) the total mass of money in the hands of the population will increase;
- b) current accounts of commercial banks will decrease;
- c) the discount rate and the volume of loans of the national bank are growing;
- d) the discount rate is reduced.

5. A tax policy that works on the basis of "built-in stabilizers of the economy" is called:

- a) discretionary;
- b) non-discretionary;
- c) stimulating;
- d) restraining.

6. Which of the following applies to direct methods of state regulation of the economy:

- a) monetary and credit methods;
- b) fiscal methods;
- c) targeted financing of the state;
- d) accelerated depreciation?

7. The built-in automatic stabilizers of the economy include:

- a) progressive income tax;
- b) subsidies to farmers;
- c) assistance to the unemployed;
- d) all answers are correct.

8. The Laffer curve:

- a) is always used in practice;
- b) demonstrates a general pattern related to the existence of a limit on the growth of tax rates;
- c) has a theoretical value;
- d) the correct answers are b) and c).

9. The annual budget balanced by the government will:

- a) contribute to weakening inflation;
- b) stimulate aggregate demand;
- c) increase the fluctuations of the economic cycle;
- d) align the fluctuations of the economic cycle.

10. Antiinflationary fiscal policy provides for:

- a) an increase in taxes and the level of government spending;
- b) increasing the level of taxation and reducing the government spending;
- c) a decrease in both government spending and tax revenues;
- d) tax cuts and government spending.

Answers: 1d; 2b; 3b; 4a; 5b; 6c; 7d; 8d; 9c; 10c.

## 12. Foreign trade policy

Every national economy is an open economic system. Foreign trade policy is therefore one of the most important macroeconomic variables in international comparisons. Thus, section 12 examines the balance of payments that shows how much merchandise and how many services a country sells abroad, how much it buys, how much it borrows and repays in debts and investments, how much it spends or accumulates in reserves. The focus is also on such an important factor as the exchange rate which shows the ratio between the monetary units of different countries. The information about state regulation of foreign trade policy is also provided.

12.1. The balance of payments.

12.2. The exchange rate.

12.3. State regulation of foreign trade policy.

**Key terms:** open economy, balance of payments, current account, capital account, official reserves of the state, currency, rate of exchange, direct currency quote, reverse currency quote, purchasing power parity, fee.

### 12.1. The balance of payments

Almost every national economy in varying degrees is an open economic system, meaning interaction with the economies of other countries. The interconnection of the national economy with the subjects of the foreign sector is shown in the process of movement of the balance of payment indicators.

The balance of payments is a statistical document that describes all financial charges that come into the country from abroad, and all payments abroad over a certain period of time (year, quarter, month). The balance of payments shows how much merchandise and how many services a country sells abroad, how much it buys, how much it borrows and repays in debts and investments, how much it spends or accumulates in reserves. Indeed, the balance of payments displays the current economic stability of the country, as well as the expected changes in the exchange rate of the

national currency. The balance of payments includes all foreign trade policy of the country.

The balance of payments is usually used to evaluate the financial situation of the country in the international market. The balance of payments is an important indicator determining the country's involvement in global trade and international economic relations, and also reflects the capacity to pay. The state of trade and payment balances influences the exchange rate. Transactions resulting in the influx of foreign exchange into the country are taken into account as a credit in the balance of payments. Transactions resulting in the reflux of foreign exchange from the country are taken into account in the debit of the balance of payments. In short, a credit is an outflow of valuables outside the country, for which the country receives payments in foreign currency. A debit is an inflow of valuables into the country for which you must pay in foreign currency.

*Account balance of payments* is the ratio between payments received from abroad and payments made abroad.

If payments received from abroad exceed payments made abroad, an active balance of payments is formed. In the opposite case, when a country spends more abroad than it receives from outside, an adverse balance of payments is formed, which is called a deficit.

With a gap in the balance of payments, the National Bank reduces its reserves of foreign currency, and with a positive balance it forms reserves. The gap in the balance of payments on current transactions is mainly financed by net capital forthcoming on the capital account. Conversely, an asset in the current balance of payments is accompanied by a net outflow of capital. In the latter case, the surplus funds of the current balance of payment are used to purchase real estate or loans to other countries.

Deviation of the balance of payments is unfavorable both in plus and minus. For example, a sharp increase in the external surplus leads to fast monetary growth and thereby promotes inflation. A sharp increase in the negative balance can lead to the exchange-rate depreciation.

The balance of payments consists of three main groups of accounts: a current account, a flow of funds account and a reserve account of the National Bank of the country. *The balance of payments framework* and operations on debit and credit are given in the table.

### The balance of payments framework

Account	Transaction	Credit (+)	Debit (-)
A. Current account	Balance of goods and services (trade balance)	Export of goods and services	Import of goods and services
	Primary income balance (from investments and payments)	Incomes from investments and payments received by residents from non-residents	Incomes from investments and payments received by non-residents from residents
	Secondary income balance (transfers)	Income transfers	Transfers
B. Capital account	Purchase and sale of capital assets	Sale (capital imports)	Purchase (capital exports)
C. Financial account	Direct (10 % and more common stock)	Sell-off in financial assets	Purchase of financial assets
	Portfolio investment		
	Other investments (loan capital movement)	Borrowing	Lending
	Errors and omissions	Discrepancy between the amounts of credit and debit transactions	
D. Aggregated balance	= A + B - C		
E. Reserves and related articles	Reserve assets	Reduction	Growth
	IMF loans	Increasing the obligations	Reducing the obligations

The preparation of the balance of payments presupposes the following ratios:

the sum of the current and capital transactions are equal to the sum of the financial account and reserves ( $A + B = C + E$  or  $D = E$ );

taking into account official reserves, credit transactions are equal to the debit amount. The difference in this proportion is explained by the use of various sources of statistical information. If it happens, it is covered by the article "Errors and omissions". A negative balance of this article for a prolonged period of time may also indicate illegal export of capital from the country.

*The current account* includes the trade balance, the balance of services and the balance of transfers. The trade balance distinguishes the ratio (in value terms) between the merchandise that is imported and exported per year (quarter, month). This is one of the leading indicators of the country's economic situation in the global market. It reflects the total payments for the export and import of merchandise.

*The balance of services* reflects the total payment of interest on assets (stocks, bonds, etc.), net investment income, payment of foreign transportation, tourism, the purchase and sale of patents and licenses, international insurance, as well as the acquisition of foreign currency by private citizens in banks in terms of import and export.

*The balance of transfers* reflects the balance of remittances of private citizens, subsidies and personal loans, pensions, gifts, grants and other types of free assistance.

*The capital account* reflects the total payments for the acquisition and sale of capital assets, such as stocks, bonds, bank deposits, etc. The sale of capital assets to foreign investors represents the import of capital, the acquisition of assets abroad represents the export of capital.

The state repays the balance of payments deficit using the official foreign exchange reserves of the National Bank.

If the passive balance is negligible, then you can adapt to the disequilibrium. But, if the balance of payments deficit becomes chronic, then a balance of payments crisis arises. This crisis can be overcome only with the help of macroeconomic adjustment.

*Macroeconomic adjustment* is carried out in three ways: direct control, internal price and income adjustments, exchange rate regime adjustment.

*Direct control* includes such measures as restricting imports, increasing duties, restricting the transfer of income of enterprises and individuals abroad, reducing transfers, exporting capital, and subsidizing exports. The direct control method is effective only in the short term. In the long term, such measures lead to the loss of foreign investors and other adverse consequences of foreign economic relations.

*Internal adjustment of prices and incomes* is the use of antiinflationary policies domestically, which leads to a decline in personal incomes, a decrease in production and investment, a reduction in imports and an increase in exports. However, at the same time, during deflation, the exchange rate of the national currency rises, which is favorable for imports and does not promote exports.

*Adjustment of the exchange rate regime* is a change in the exchange rate, including devaluation and revaluation of the currency at a fixed exchange rate and a decrease or increase in the floating exchange rate. This is carried out to make export cheaper (in foreign currency), and import more expensive, or conversely, depending on the needs of the state. This method works with some delay, sometimes up to a year, because it takes time for both importers and exporters to review their contracts.

## 12.2. The exchange rate

A currency is the monetary unit of a country. The currency is also the money of foreign countries, a credit medium of circulation and payment, denominated in foreign monetary units.

There are many types of currencies:

*national*, which is issued by the state and has circulation, primarily in the country;

*convertible* – freely exchanged for any other currency of the world;

*non-convertible* which is used within one country;

*firm* – a sound currency with a stable exchange rate;

*soft* – an unstable currency regarding its face value and value to the rates of other currencies.

Since each country uses national currency in its calculations, the problem of currency exchange arises when a country has to pay for imported foreign goods and services. This ratio is of great importance for exchange of one currency for another. This ratio is called the exchange rate.

*The exchange rate* is the value of one currency, expressed in units of another currency. It is also the ratio between the monetary units of different countries, which is determined by their purchasing power and other factors, such as the balance of payments position, inflation, and interstate capital migrations.

*Currency convertibility* (from the Latin *convertere* – to change, convert) is a free, without any restrictions, exchange of a national currency for a foreign one, as well as the use of foreign currency in transactions with solid and financial assets.

Based on convertibility there are fully convertible, partially convertible and closed (non-convertible) currencies.

*A fully convertible currency* is the currency that is fully exchanged for other foreign currencies and is used as an international means of payment.

A fully convertible currency can be used both by a resident of the country and by a non-resident, both by an individual and legal entities for trade settlements on any international transactions. These are such currencies as the American Dollar, the British Pound Sterling, the Japanese Yen, the Euro, the Canadian Dollar, the Swiss Franc.

*Partially convertible currencies* are the currencies of countries where currency restrictions are applied to residents and certain types of exchange operations. Partially convertible currencies are only exchanged for some foreign currencies and not for all types of international payment transactions.

*Closed (non-convertible) currencies* are the currencies of countries where there is an embargo on the exchange of national currencies for foreign ones; there are restrictions and a ban on the import and export, purchase and sale, the exchange of national and foreign currency and other means of exchange control.

Fixing the exchange rate of a national monetary unit towards the foreign monetary unit is called a currency quotation. Currency quotation can be direct and reverse. In the case of direct quotation, a foreign currency unit is expressed in the units of the national currency (e.g. 1 US dollar = 25 hryvnias), while in the case of reverse quotation the national currency unit is expressed in a foreign currency (1 hryvnia = 0.04 US dollars).

In international trade, each transaction with a foreign currency includes transactions with two currencies, and it is very important to know which one is the base currency (or fixed) and the quotation currency (or counter-currency). The quotation currency is the denominator, and the base currency is the numerator. When the numerator grows, the base currency strengthens its position and becomes more expensive; when the numerator decreases, the base currency weakens its position and becomes cheaper.

On the current exchange market, instead of the term "the exchange rate", "the buyer's and seller's exchange rate" is used. The buyer's rate is the rate at which a resident bank buys a foreign currency for the national currency. The seller's rate is the rate at which a resident bank sells a foreign currency for the national currency. The difference between the two rates is called margin and is the earnings of a dealer working in the foreign exchange market and trading in a foreign currency.

Exchange rates also vary depending on the type of currency transaction. So, there is the concept of a cross rate, which is a quotation of two foreign currencies towards the third one. For example, if the hryvnia against the



dollar is 1 : 25, and the hryvnia against the euro is 1 : 28, then the cross-rate between the dollar and the euro is 25 : 29, or 1 euro = 1.12 dollars.

It is important for a country to distinguish between the nominal and real exchange rates. The nominal exchange rate is what we mean by the exchange rate:

$$e = C_f / C_d, \quad (12.1)$$

where  $e$  is the nominal exchange rate;

$C_f$  is the foreign currency;

$C_d$  is the national currency.

The real exchange rate is the relative price of the goods that make up the consumer basket made in two countries. The real exchange rate shows the ratio of the exchange of goods from one country to another. You can determine the real exchange rate as follows:

$$e = e \cdot P_d / P_f, \quad (12.2)$$

where  $e$  is the nominal exchange rate;

$e$  is the real exchange rate;

$P_d$ ,  $P_f$  is the level (index) of domestic and foreign prices, respectively.

If domestic prices rise, so does the nominal exchange rate. This means that the national currency is becoming cheaper. Thus, the factors determining the rise in prices in the country also cause an increase in the exchange rate.

So, each country involved in international trade exchanges its national currency for other currencies. Foreign exchange transactions, or the exchange of the currency of one country for the currency of another at a certain nominal rate, are carried out in the foreign exchange market. The foreign exchange market is a system of relations connected with the buying and selling of foreign currency and the implementation of other transactions. The main purpose of the foreign exchange market is to provide its participants with a foreign currency and exchange rate regulation. Foreign exchange operations in most cases are carried out in non-cash form, and only a small share of the foreign exchange market accounts for the trading of banknotes and the exchange of cash currency. The foreign exchange market is directly affected by the balance of payments. With a surplus, national entities accumulate surpluses of foreign currency, and they exchange them for the national one.

The National Bank regulates the foreign exchange market (ensures the balance of supply and demand) by purchasing and selling a foreign currency from its reserves. Such actions of the National Bank in the foreign exchange market are called interventions. In case of a currency deficit (a passive balance of payments), the National Bank sells the currency from its reserves in the foreign exchange market and it buys the foreign currency in excess in the case of an active balance of payments.

*The exchange rate regime*, or currency regime, is a framework for determining the nominal exchange rate in the foreign exchange market with the participation of the state. The administrative and market mechanisms of exchange rate formation can be used.

*The administrative regime* acts in the form of a multiplicity of exchange rates, that is, differentiated exchange rate ratios of currencies for various types of transactions, product groups and regions. The administrative currency regime is used as a stabilization measure in the conditions of a structural crisis of the economy to slow down inflation, accumulate international reserves, etc.

Among the market currency regimes there are three main ones: fixed; managed floating, or interim; freely floating. The fixed exchange rate regime is the officially established ratio between the national currencies, while a temporary deviation in one or another direction is allowed by no more than 2.25 %. This regime is created by the state in case of hyperinflation or a currency crisis, in the transition from an administrative economy to a market economy, or for political reasons.

*The managed floating (interim) regime* is a certain official ratio between the national currencies, allowing small fluctuations of the exchange rate in accordance with the established rules. This mode includes several subtypes: 1) the adjusted exchange rate regime which is manifested in cases when the exchange rate automatically changes when the set of economic indicators changes. The current exchange rate may automatically change, for example, following a change in the inflation rate in the state itself or in the partner country; 2) creeping (sliding) fixation which is a mechanism for establishing the exchange rate with possible small fluctuations around a central parity, which provides for a regular change by a certain amount. Currency parity is the legislatively established ratio of the national currency to other currencies.

In some countries, a significant width of the currency corridor is established – up to 20 % (10 % each side of the parity). The wider the currency corridor, the softer the government's policy in the macroeconomic sphere and

the less often there is a need to change its parameters. Sometimes, in order to stimulate certain sectors of the economy, the government sees it a merit to support a slightly undervalued exchange rate of the national currency, for example, to boost exports and correct imbalances in the balance of payments, or to minimize exchange rate fluctuations to control inflation.

Under the freely floating exchange rate regime, the exchange rate changes freely under the influence of supply and demand, which the state can influence under certain conditions through currency interventions.

In the world community, international monetary and economic relations are fixed by interstate agreements in the form of a monetary system. The monetary system is institutions, rules and methods that have been established spontaneously or enshrined in law and international agreements, which make international payments. The currency system includes: determination of the main international payment and settlement funds; the regimes of currency parities and foreign exchange markets; the currency convertibility conditions; the interstate foreign exchange markets; the interstate institutions regulating international monetary relations.

### **12.3. State regulation of foreign trade policy**

The foreign economic policy of the state may be open, moderate or protectionist.

*Protectionism* is a targeted protection of the domestic market from the receipt of foreign goods. Foreign economic policy of the state, usually involves a certain combination of elements of an open economy and protectionism. In the pure state, protectionism or an open economy does not occur.

Depending on the method of state influence on foreign economic relations, administrative and economic forms of regulation are distinguished. Administrative forms are methods of direct impact, they are mainly restrictive. For example, setting quotas, using licenses, applying restrictions, etc. The government uses administrative forms of regulation of foreign economic activity when conducting a protectionist policy in order to protect domestic producers.

Economic regulation is carried out through the use of economic measures – excise taxes, taxes, duties, exchange rates, etc.

The foreign economic policy of the state consists mainly in controlling the movement of the balance of payment indicators and regulating the exchange rate (Fig. 12.1).

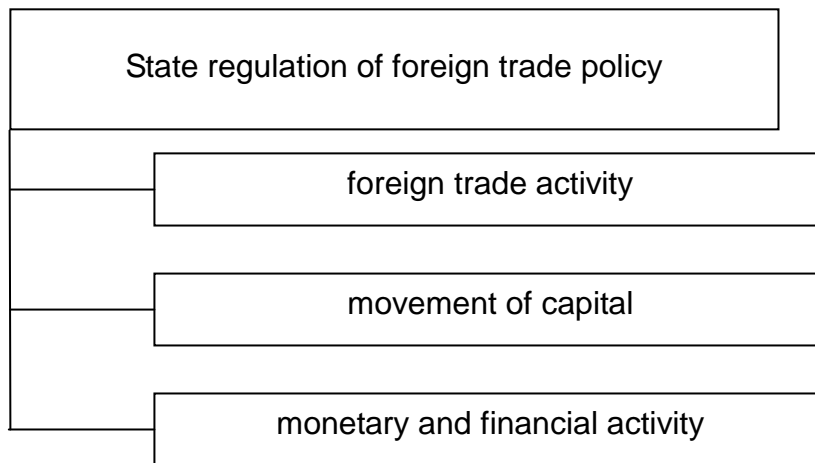

**Fig. 12.1. The main forms of regulation of foreign economic activity**

It is known that the economy of any country, regardless of its size and level of economic development, is interconnected with the outside world through the mechanism of foreign trade. The size of exports (EX) and imports (IM) influences domestic prices, exchange rates of national currencies, interest rates, aggregate demand and GDP, employment rate and macroeconomic equilibrium.

*Import* is the purchase of goods and services by residents of a given country from foreigners. *Export* is the sale of goods and services by residents of a given country to foreigners.

*State regulation of foreign trade relations* is connected with the implementation of tariff and non-tariff methods. Tariff methods are aimed at the regulation of foreign trade relations using a system of duties.

*Custom's duty* (tax) is a type of mandatory tax levied by the customs authorities of a country when importing goods into or exporting from this territory. The amount of the duty is determined by the customs tariff, which contains lists of dutiable goods. Fees are imposed to protect the domestic producer, as they increase the first cost of imported goods, and also serve as a source of replenishment of budget funds.

Non-tariff barriers are the limitation in foreign trade, not related to the application of duties. Tariff and non-tariff regulation methods form the basis of the protectionist policy of the state.

The structure of foreign trade is an important factor that can influence the level of economic development of a country and the living standards of the population. The main methods of state regulation of foreign trade are given in Fig. 12.2.

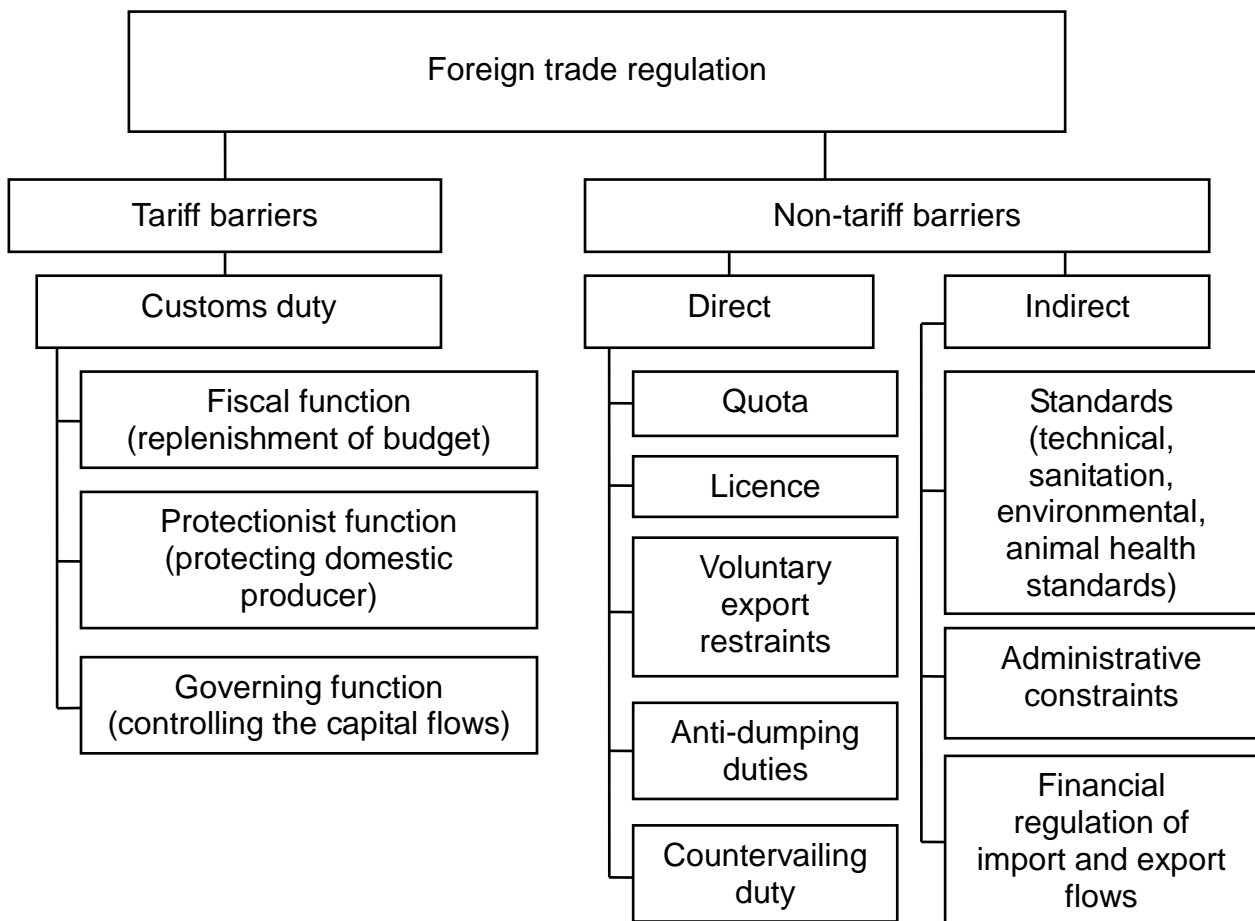

Fig. 12.2. **The methods of state regulation of foreign trade**

*State regulation of capital movement* aims, firstly, to attract or restrict foreign investment in the national economy and, secondly, to encourage residents' investments in other countries' economies (foreign investments).

The need to regulate foreign investment is due to the fact that, on the one hand, the import of capital means attracting additional financial and material resources to the national economy, which contributes to its economic growth. On the other hand, excessive foreign investment can lead to a threat to national security associated with the transfer of important economic objects into the hands of foreign owners and the export of profit by foreign companies (including dividends, interest, royalties). Most countries of the world market economy pursue policies aimed at attracting foreign capital.

According to the method of impact on foreign investment, two groups of methods are distinguished:

- methods that work to attract foreign investment – these are tax and customs benefits, guarantees against the nationalization of foreign property, the possibility of repatriation of profits, the provision of concessions, and others;

- methods that work to restrict foreign investment – this is the limitation of the share of foreigners in the authorized capital of companies; determination of the areas of activity available for foreign capital, including the cases of creating joint ventures; restrictions on the repatriation of profits and capital; use of local inputs.

In practice, the state usually uses a set of measures of both groups.

The second direction of state regulation of capital flows is the export of capital, or the export of investments by residents abroad. Capital is exported abroad in order to increase profits, in the form of direct and portfolio investments, loans, capital on bank deposits and various accounts. State regulation of capital exports is to support the export of capital, primarily direct investment. This is assistance in finding a foreign partner, in organizing a preliminary feasibility study, analyzing a business plan, implementing investment projects, providing tax measures, loans, and insurance.

Sometimes capital is exported abroad in order to preserve it by placing it in more stable and reliable conditions – a "leak" of capital abroad, the main reasons for which are the lack of a favorable investment climate, political instability, high taxes, inflation, and the lack of guarantees for investors. An unofficial export of illegally obtained capital is also possible.

State regulation of capital exports is designed to restrict illegal export of capital.

*Currency regulation* is a foreign exchange restriction. Currency restrictions may regulate the transactions of residents and non-residents with currency or currency values. These are restrictions on the transfer of foreign currency funds abroad under capital and (or) current items of the balance of payments, restrictions on the ability of residents to buy foreign goods, services, and provide loans abroad. Foreign exchange restrictions may concern both foreign trade and the movement of capital. Exchange restrictions are part of the foreign exchange control by the government.

*Foreign exchange control* is a system of government measures that control all agreements between a country and the rest of the world which includes control over the legality of foreign exchange transactions, timely return of currency on export transactions, on the correctness of settlements on import transactions, etc. As the economy sharply deteriorates and an increase in the balance of payments deficit is observed, the state takes measures to tighten foreign exchange restrictions, especially with regard to the export of capital.

## Glossary

**Balance of payments** is a document describing all cash payments received in a country from abroad, and all payments abroad during a certain period of time (year, quarter, and month).

**Currency** is the monetary unit of a country. Also, foreign currency means money of foreign countries, credit means of circulation and payment, denominated in foreign monetary units.

**Exchange rate** is the price of one currency, denominated in units of another currency, as well as the ratio between the monetary units of different countries, which is determined by their purchasing power and other factors.

**Protectionism** is a targeted protection of the domestic market from the receipt of foreign goods.

**Customs duty** is a type of mandatory tax levied by the customs authorities of a country when importing (or exporting) goods into its territory.

### Problems with examples of solutions

1. The table below shows a list of foreign economic transactions between country A and other states:

Table

Foreign economic transactions	Amount (mln euros)
Purchase of securities of foreign companies by residents of country A	70
Imports of goods and services in country A	120
Exports of goods and services from country A	140
Remittances from other countries to country A	50
Transfer of securities of state enterprises to foreigners	80
Import of gold to country A	80

Make a balance of payments of country A.

*Solution.* The balance of payments consists of debit and credit, and therefore we assign each transaction to a certain position:

Items	Debit	Credit
	Million euros	
Imports of goods and services in country A	120	–
Exports of goods and services from country A	–	140
Purchase of securities of foreign companies by residents of country A	70	–
Sale of securities of state enterprises to foreigners	–	80
Money transfers from other countries to country A	–	50
Import of gold to country A	80	–
Total	270	270

The transactions of country A with other states indicate a balanced external economic budget of the country.

### Questions for self-assessment

1. Explain the term "open economy".
2. What types of state foreign economic policy do you know?
3. List the sections of the balance of payments and provide a description of each of them.
4. Describe the balance of payments deficit. How is it adjusted?
5. What are the nominal and real exchange rates, how do they differ and what function do they perform?
6. What is the difference between regulated and independent exchange rates?
7. Describe the forms of regulation of foreign economic activity.
8. What is, in your opinion, the effect of the policy of protectionism on different subjects of the country's economy?
9. What is a duty? What types of duty do you know? What are their functions?
10. Do you think the terms "capital export" and "capital outflow" mean the same? Explain the answer.



## Heuristic tasks

1. The indicators of the balance of payments of Ukraine (mln UAH) are as follows: the current account balance is -170; the capital account balance is +120, the visible balance "Errors and omissions" is +27. How much should the reserve assets be reduced in order to counterbalance the balance of payments?

2. Last year, the cost of a certain set of products in the US was 5,000 US dollars, and in France – 3,000 euros. Determine the purchasing power parity of the dollar to the euro.

3. If the dollar to yen rate is 1 : 107.35, and the hryvnia to dollar rate is 1 : 25, determine the cross rate between the yen and the hryvnia.

## Test

1. Current account payments do not include:

- a) merchandise exports;
- b) net investment income;
- c) transport services to foreign countries;
- d) changes in the country's assets abroad.

2. Assume that between the United States and Canada a regime of freely floating exchange rates is established. If demand for the Canadian dollar grows, it means that the price of the US dollar in Canada is declining.

- a) yes;
- b) no.

3. For each basic term, choose its correct definition:

1	Balance of payments	A	A document describing all monetary payments received from abroad and all payments abroad for a certain period of time
2	Exchange rate	B	Purchase and sale of currency from the reserves of the National Bank of the country
3	Intervention	C	Mandatory levy which is taken by the customs authorities of the state when importing goods into or exporting from a country
4	Import or export duty	D	The ratio between the monetary units of different countries determined by their purchasing power and other factors

4. Is this statement true?

The difference between the import duty and the quota is that the duty generates income to the state budget:

- a) yes;
- b) no.

5. Which of the following forms of trade barriers is (are) not a significant obstacle to free trade:

- a) import duty;
- b) import quota;
- c) export and import licenses;
- d) all answers are incorrect.

6. Fill the gap:

Raising the ... productivity level helps to increase the exchange rate of the national currency (other things being equal).

7. If the exchange rate was 1 dollar = 22 UAH, and became 1 dollar = 25 UAH, then this is:

- a) revaluation;
- b) devaluation;

8. When a country's currency devaluates, it is considered that:

- a) the country has abandoned the gold standard;
- b) the country has a trade deficit;
- c) the domestic purchasing power of a unit of currency has decreased;
- d) the government will buy gold and other currencies at a higher price.

9. If Ukraine's GDP decreases, then with a system of floating exchange rates:

- a) the import and value of the hryvnia will decrease;
- b) the import and value of the hryvnia will increase;
- c) imports will increase and the value of the hryvnia will decrease;
- d) imports will decrease, and the value of the hryvnia will rise.

10. The balance of payments deficit:

- a) does not change the monetary base;
- b) does not affect the amount of money in circulation;
- c) reduces the amount of money in the country;
- d) increases the amount of money in the country.

Answers: 1d; 2a; 3 – 1A, 2D, 3B, 4C; 4a; 5d; 6 human; 7b; 8d; 9c; 10c.

## References and bibliography

### Main

1. Агапова Т. А. Макроэкономика : учебник / Т. А. Агапова, С. Ф. Серегина ; под общ. ред. д-ра экон. наук, проф. А. В. Сидоровича ; МГУ им. М. В. Ломоносова. – Москва : Изд-во "Дело", 2007. – 496 с.
2. Базилевич В. Д. Макроэкономика : учебник / В. Д. Базилевич, Е. С. Базилевич, Л. А. Баластрик. – Киев : Знання, 2015. – 694 с.
3. Вечканов Г. С. Макроэкономика : учебное пособие / Г. С. Вечканов, Г. Р. Вечканова. – Санкт-Петербург : Изд-во "Питер", 2008. – 240 с.
4. Гронтковська Г. Е. Макроекономіка : практикум / Г. Е. Гронтковська, А. Ф. Косік. – Київ : Центр учбової літератури, 2011. – 400 с.
5. Калініченко О. В. Макроекономіка. Практикум : навчальний посібник / О. В. Калініченко, О. Д. Плотник. – Київ : Центр учбової літератури, 2010. – 656 с.
6. Клименко Е. Н. Макроэкономика : учебное пособие для самостоятельного изучения дисциплины / Е. Н. Клименко, О. Н. Крюкова, М. С. Бриль. – Харьков : ХНЭУ им. С. Кузнеца, 2015. – 244 с.
7. Макроекономіка : навчальний посібник / О. М. Кліменко, О. М. Крюкова, В. М. Філатов та ін. ; під заг. ред. О. М. Кліменко. – Харків : Инжэк, 2011. – 250 с.
8. Мэнкью Н. Г. Принципы макроэкономики : учебник для вузов / Н. Г. Мэнкью. – 4-е изд. – Санкт-Петербург : Изд-во "Питер", 2010. – 576 с.
9. Практикум з навчальної дисципліни "Макроекономіка" для студентів всіх спеціальностей усіх форм навчання / О. М. Крюкова, О. М. Кліменко, М. С. Бриль, Т. С. Черкашина. – Харків : Вид-во ХНЕУ, 2010. – 108 с.
10. Черкашина Т. С. Виробнича функція Кобба – Дугласа як інструмент політики економічного зростання України в умовах ринкових реформ / Т. С. Черкашина // Економіка та суспільство. – 2019. – Вип. 20. – С. 103–112.
11. Evans M. K. Macroeconomics for Managers / M. K. Evans. – Oxford, England; Malden, Mass. : Blackwell Publishing, 2016. – 838 p.
12. Figueroa A. A unified theory of capitalist development: growth, inequality, and the environment / A. Figueroa. – Buenos Aires : Cengage Learning, 2012. – 305 p.
13. Garin J. Intermediate Macroeconomics / J. Garin, R. Lester, E. Sims. – South Bend, Indiana: University of Notre Dame, 2018. – 1018 p.

14. Huntington H. The Historical "Roots" of U.S. Energy Price Shocks / H. Huntington // Energy Economics. – 2017. – Vol. 62. – February. – P. 204–216.
15. Lipsey R. G. Economics / R. G. Lipsey, K. A. Chrystal. – Oxford : Oxford University Press, 2015. – 507 p.
16. McConnell C. R. Economics: principles, problems, and policies / C. R. McConnell, S. L. Brue. – Boston : McGraw-HillIrwin, 2015. – 818 p.
17. Moss David A. A Concise Guide to Macroeconomics / D. A. Moss. – Boston, Massachusetts : Harvard Business Publishing, 2014. – 224 p.
18. Ven, de, D. J. Historical energy price shocks and their changing effects on the economy / D. J. de Ven, R. Fouquet // Energy Economics. – 2017. – Issue 62. – P. 204–216.
19. Zadoia O. A. Transformations of savings into investments: role of financial intermediaries / O. A. Zadoia // Науковий вісник НГУ. – 2017. – № 2. – С. 165–170.

### **Information resources**

20. The official site of the European Union. – Access mode : [www.ec.europa.eu](http://www.ec.europa.eu).
21. The official site of the Organization for Economic Co-operation and Development (OECD). – Access mode : [stats.oecd.org](http://stats.oecd.org).
22. The official site of the State Statistics Committee of Ukraine. – Access mode : [www.ukrstat.gov.ua](http://www.ukrstat.gov.ua).
23. The official site of the U.S. Bureau of Labor Statistics'. – Access mode : [www.bls.gov](http://www.bls.gov).
24. The official site of the U.S. Census Bureau. – Access mode : [www.census.gov](http://www.census.gov).
25. The official site of the U.S. Department of Commerce. – Access mode : <https://www.commerce.gov>.
26. The official site of the U.S. Federal Reserve System. – Access mode : [www.federalreserve.gov](http://www.federalreserve.gov).
27. The official site of the World Bank. – Access mode : [www.worldbank.org](http://www.worldbank.org).

### **Methodological support**

28. Cherkashyna T. S. Personal education system on the academic discipline "Macroeconomics" [Electronic resource] / T. S. Cherkashyna. – Access mode : <http://www.ikt.hneu.edu.ua/course/view.php?id=3795>.

НАВЧАЛЬНЕ ВИДАННЯ

**Бріль Михайло Сергійович**  
**Кліменко Олена Миколаївна**  
**Лісна Ірина Федорівна та ін.**

## **МАКРОЕКОНОМІКА**

**Навчальний посібник**

*Самостійне електронне текстове мережеве видання*

Відповідальний за видання *М. А. Мащенко*

Відповідальний редактор *М. М. Оленич*

Редактор *З. В. Зобова*

Коректор *З. В. Зобова*

Розкрито основні теоретичні положення сучасної макроекономіки. Проаналізовано основні ринки та структуру складових економічної політики. Уміщено статистичні дані, які характеризують основні макроекономічні показники не лише України, але й інших постсоціалістичних країн Центральної та Східної Європи (Польщі, Чехії, Словаччини, Словенії, Угорщини), а також провідних країн світу, зокрема Китаю, США та Канади. Навчальний посібник зорієнтований на формування компетентностей студентів: аналіз основних макроекономічних показників та оцінювання ключових макроекономічних проблем, вивчення ролі основних суб'єктів господарювання у сучасному економічному кругообігу, ухвалення оптимальних економічних рішень основних економічних суб'єктів (домогосподарств, підприємств, держави, нерезидентів країни) в умовах макроекономічної нестабільності та глобальної турбулентності.

Рекомендовано для студентів, аспірантів, викладачів закладів вищої освіти, а також фахівців-практиків, які цікавляться актуальними економічними проблемами.

План 2020 р. Поз. № 27-ЕНП. Обсяг 237 с.

Видавець і виготовлювач – ХНЕУ ім. С. Кузнеця, 61166, м. Харків, просп. Науки, 9-А

*Свідоцтво про внесення суб'єкта видавничої справи до Державного реєстру*  
**ДК № 4853 від 20.02.2015 р.**